

AGENCEMENT
dyade

Mobilier pour établissements recevant du public

**Printemps
Été**



*Spring
Summer*
AGENCEMENT
dyade

681 Chemin des Carrières
84410 Crillon le Brave
tel: 04 90 65 65 48 fax: 04 90 65 69 13
contact@agencementdyade.fr
www.agencementdyade.fr

Printemps
Été



*Spring
Summer*





Légende

Legend

	Largeur totale <i>Total width</i>		Diamètre du plateau <i>Table top diameter</i>
	Profondeur totale <i>Total depth</i>		Hauteur réglable de la table <i>Adjustable table height</i>
	Hauteur totale <i>Total height</i>		Dimensions plateau min. ou max. conseillées <i>Min. or max. advised table top sizes</i>
	Hauteur assise <i>Seat height</i>		Conditionnement <i>Packaging</i>
	Hauteur d'accoudoir (centre) <i>Armrest height (centre)</i>		Mat-Faible réflectivité <i>Low light reflectivity</i>
	Poids Net <i>Net weight</i>		Anti-traces de doigts <i>Fingerprint-proof</i>
	Empilable <i>Stackable</i>		Hydrofuge <i>Water repellent</i>
	Diamètre de l'assise <i>Seat diameter</i>		Polyester recyclé <i>Recycled polyester</i>
	Diamètre de la base <i>Base diameter</i>		Classement non-feu (+N° Norme) <i>Fire resistant rating (+N° Norm)</i>
	Hauteur du tabouret <i>(Bar) Stool height</i>		Nettoyage facile <i>Easy clean</i>
	Longueur de la croix <i>Cross length</i>		Lavage Facile <i>Easy care</i>
	Longueur X largeur de la base <i>Base length x width</i>		Forest Stewardship Council <i>"Gestion responsable des forêts"</i>
	Hauteur du piètement <i>Table base height</i>		Produit certifié - Faibles émissions de substances chimiques - UL 2818 <i>Product certified for low chemical emissions - UL 2818</i>
	Diamètre de la base <i>Base diameter</i>		Résistance aux UV <i>UV resistant</i>
	Longueur de la base <i>Base length</i>		Test de longévité sur le système pliant : 2000 cycles <i>Folding mechanism durability test : 2000 cycles</i>
	Longueur X largeur du plateau <i>Table top length x width</i>		ISO 9227:2017 Utilisation Bord de mer <i>Standard ISO 9227:2017 - Seaside use</i>
	Longueur X largeur de la base <i>Base length x width</i>		Usage extérieur <i>Outdoor use</i>
	Hauteur de la table <i>Table height</i>		Usage intérieur uniquement <i>Indoor use only</i>
	Dimensions de la table pliée <i>Folded table measurements</i>		À monter <i>To be assembled</i>
	Pliable & encastrable <i>Foldable & stackable</i>		Numéro de l'échantillon <i>Sample reference number</i>
	Table Pliante <i>Folding Table</i>		

Extérieur - *Outdoor*

8-105 Assises
Seats

106-113 Tables
Tables

114-117 Parasol
Parasol

118-127 Piètements
Table Bases

128-135 Plateaux
Table Tops

Intérieur - *Indoor*

138-245 Assises
Seats

246-251 Tables Basses
Low tables

252-263 Piètements
Table Bases

264-273 Plateaux
Table Tops

274-277 Meubles
Furniture

Réception - *Catering*

280-285 Assises
Seats

286-289 Tables
Tables

Divers - *Miscellaneous Infos*

292-301 Informations techniques
Technical information

302-305 Correspondance Pieds/Plateaux
Matching table tops and bases

306 Pièces détachées
Spare parts

308-315 Index
Index







Extérieur - Outdoor

Dax

New

Chaise - Chair



Rotin Noisette
Nut Rattan

Structure en aluminium - Peinture époxy : Bamboo look caramel - Épaisseur tube 1,7mm - Diamètre tube 25mm - Tressage PE.
Aluminum frame - Epoxy powder coating : Caramel Bamboo look - Tube thickness 1,7mm - Tube diameter 25mm - PE wicker.



46 56 87 46 3,5



S4
R16



Dax

Orléans

Chaise - Chair



Rôtin Noisette
Nut Rattan

Structure en aluminium - Peinture époxy : Bamboo look caramel - Épaisseur tube 1,5mm - Diamètre tube 28mm - Tressage PE.
Aluminum frame - Epoxy powder coating : Caramel Bamboo look - Tube thickness 1,5mm - Tube diameter 28mm - PE wicker.



S4
R16



Orléans

Rochelle

Fauteuil - *Armchair*



Rotin Noisette
Nut Rattan

Structure en aluminium - Peinture époxy : Bamboo look caramel - Épaisseur tube 1,5mm - Diamètre tube 28mm - Tressage PE.
Aluminum frame - Epoxy powder coating : Caramel Bamboo look - Tube thickness 1,5mm - Tube diameter 28mm - PE wicker.

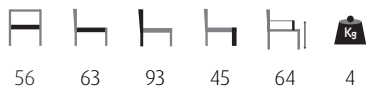

56 63 93 45 64 4



S4
R16



Rochelle

Laval





New

Tabouret - Barstool



Rotin Noisette
Nut Rattan

Structure en aluminium - Peinture époxy : Bamboo look caramel - Épaisseur tube 1,5mm - Diamètre tube 28mm - Tressage PE.
Aluminum frame - Epoxy powder coating : Caramel Bamboo look - Tube thickness 1,5mm - Tube diameter 28mm - PE wicker.

   
36 47 76 2,7



S4
R16



Laval

Brest

Tabouret - Barstool



Rôtin Noisette
Nut Rattan

Structure en aluminium - Peinture époxy : Bamboo look caramel - Épaisseur tube 1,5mm - Diamètre tube 28mm - Tressage PE.
Aluminum frame - Epoxy powder coating : Caramel Bamboo look - Tube thickness 1,5mm - Tube diameter 28mm - PE wicker.



36 49 45 2



S4
R16



Brest

Murcia

New

Fauteuil - Fauteuil



Noir
Black

Taupe
Taupe

Terracotta
Terracotta



Structure en aluminium - Peinture époxy - Épaisseur tube 1,35mm renforcé par tube intérieur de 1mm - Diamètre tube 25mm - Tressage corde textilène - Coussin polyester 4cm inclus, fixé par velcro.

Aluminum frame - Epoxy powder coating - Tube thickness 1,35mm reinforced by inner tube of 1mm - Tube diameter 25mm - Textilene rope - Polyester cushion 4cm included, fixed by velcro.

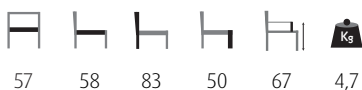

57 58 83 50 67 4,7



S23,S24,S25
R20,R21,R22,
R23,R24,R25



Murcia

Cadix

New

Ensemble - Set



Anthracite
Anthracite

Structure en aluminium - Peinture époxy : Anthracite - Fauteuils : épaisseur tube pieds 2mm ; diamètre tube pieds 30mm -
Table : épaisseur tube 1,6mm ; diamètre tube 30mm - Corde Textilène - Coussins polyester inclus.

Aluminum frame - Epoxy powder coating : Anthracite - Armchairs : leg tube thickness 2mm ; legs tube diameter 30mm -
Table : tube thickness 1,6mm ; tube diameter 30mm - Textilene rope - Polyester cushions included.



74	73	73	45	60	9,2	Fauteuil 1 place <i>One-Seater</i>
150	73	73	45	60	15,4	Fauteuil 2 places <i>Two-Seater</i>



110x53	40	3,7	Table basse <i>Low table</i>
--------	----	-----	--------------------------------



S21
R17,R18



Cadix

Savana

Fauteuil - Armchair



Paille
Straw

Olive
Olive



Structure en acier - Peinture époxy : Anthracite - Épaisseur tube 1mm - Diamètre tube 22mm - Tressage PE torsadé 5mm.
Steel frame - Anthracite powder coating - Tube thickness 1mm - Tube diameter 22mm - Twisted PE rattan 5mm.

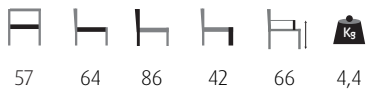

S1+R1
S1+R2



Savana

Amsterdam

Fauteuil - *Armchair*



Paille
Straw



Olive
Olive



Anthracite
Anthracite



Structure en aluminium - Peinture époxy : Anthracite - Épaisseur tube 32x1,2mm à 19x2mm - Tressage PE torsadé 5mm.
Aluminum frame - Anthracite powder coating - Tube thickness 32x1,2mm to 19x2mm - Twisted PE Rattan 5mm.



S1+R1
S1+R2
S1+R3



Amsterdam

Breda

Tabouret - Barstool



Paille
Straw

Olive
Olive

Anthracite
Anthracite

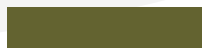

Structure en aluminium - Peinture époxy : Anthracite - Épaisseur tube 32x1,2mm à 19x2mm - Tressage PE torsadé 5mm.
Aluminum frame - Anthracite powder coating - Tube thickness 32x1,2mm to 19x2mm - Twisted PE Rattan 5mm.



46 58 104 76 3,2



S1+R1
S1+R2
S1+R3



Breda

Concorde

Fauteuil - *Armchair*



Anthracite
Anthracite

Structure en aluminium - Peinture époxy : Anthracite - Épaisseur tube 1,5mm - Diamètre tube 28mm - Corde textilène anthracite.
Aluminum frame - Anthracite powder coating - Tube thickness 1,5mm - Tube diameter 28mm - Anthracite textilene ropes.

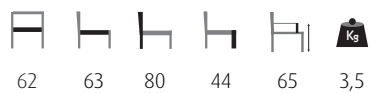



Concorde

Saint-Tropez

Fauteuil - *Armchair*



Noir
Black

Gris Pierre
Stone Grey

Stock
Limité
Limited
Stock

Structure en aluminium - Épaisseur tube avant 38x17x1,4mm ; tube arrière 25x2mm - Tressage PE rond 3,8mm avec fil d'acier.
Aluminum frame - Tube thickness: front tube 38x17x1,4mm ; rear tube 25x2mm - Round PE Rattan 3,8mm with metal wire.





Saint-Tropez

Villette

New

Chaise - Chair



Gris & Blanc
Grey & White

Noir
Black



Structure en aluminium - Peinture époxy : Bamboo look clair - Épaisseur tube 1,5mm - Diamètre tube 28mm - Tressage PE.
Aluminum frame - Epoxy powder coating : Light Bamboo look - Tube thickness 1,5mm - Tube diameter 28mm - PE Wicker.



S5
R8,R9



Villette

Madeleine

Fauteuil - Armchair



Gris & Blanc
Grey & White

Noir
Black



Structure en aluminium - Peinture époxy : Bamboo look clair - Épaisseur tube 1,5mm - Diamètre tube 28mm - Tressage PE.
Aluminum frame - Epoxy powder coating : Light Bamboo look - Tube thickness 1,5mm - Tube diameter 28mm - PE wicker.

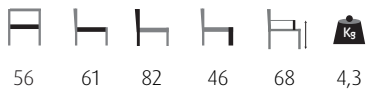

S5
R8,R9



Madeleine

Passy

Tabouret - Barstool



Gris & Blanc
Grey & White

Noir
Black



Structure en aluminium - Peinture époxy : Bamboo look clair - Épaisseur tube 1,5mm - Diamètre tube 28mm - Tressage PE.
Aluminum frame - Epoxy powder coating : Light Bamboo look - Tube thickness 1,5mm - Tube diameter 28mm - PE wicker.



39 49 76 2,5



S5
R8,R9



Passy

Reims

New

Chaise - Chair



Gris & Beige
Grey & Beige



Structure en aluminium - Peinture époxy : Bamboo look chestnut - Épaisseur tube 1,5mm - Diamètre tube 28mm - Textilène 4x4.
Aluminum frame - Epoxy powder coating : Bamboo look chestnut - Tube thickness 1,5mm - Tube diameter 28mm - Textilene 4x4.



49 55 85 47 3



S22
R19



Reims

Blois

New

Fauteuil - Armchair



Gris & Beige
Grey & Beige



Structure en aluminium - Peinture époxy : Bamboo look chestnut - Tube avant : épaisseur 2mm ; diamètre 24mm -
Tube arrière : épaisseur 1,5mm ; diamètre 28mm - Textilène 4x4.

Aluminum frame - Epoxy powder coating : Bamboo look chestnut - Front tube : thickness 2mm ; diameter 24mm - Rear tube :
thickness 1,5mm ; diameter 28mm - Textilene 4x4.



S22
R19



Blois

Dole

New

Tabouret - Barstool



Gris & Beige
Grey & Beige



Structure en aluminium - Peinture époxy : Bamboo look chestnut - Épaisseur tube 1,5mm - Diamètre tube 28mm - Textilène 4x4.
Aluminum frame - Epoxy powder coating : Bamboo look chestnut - Tube thickness 1,5mm - Tube diameter 28mm - Textilene 4x4.

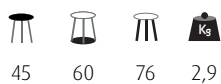

45 60 76 2,9



S22
R19



Dole

Seine

Chaise - Chair



Camel & Blanc
Camel & White



Structure en aluminium - Peinture époxy : Bamboo look naturel - Tube avant 28x1,5mm et tube arrière 24x1,5mm - Textilène 8x8.
Aluminum frame - Epoxy powder coating : Natural bamboo look - Front tube 28x1,5mm & rear tube 24x1,5mm - 8X8 Textilene.



53 56 85 45 4,1



S16
R10



Seine

Louvre

Chaise - Chair



Blanc & Bleu Océan
White & Ocean Blue

Blanc & Pimento
White & Pimento



Structure en aluminium - Peinture époxy : Bamboo look clair - Épaisseur tube 1,5mm - Diamètre tube 28mm - Textilène 8x8.
Aluminum frame - Epoxy powder coating : Light Bamboo look - Tube thickness 1,5mm - Tube diameter 28mm - Textilene 8x8.



S5
R5,R6



Louvre

Dauphine

Fauteuil - *Armchair*



Noir
Black

Structure aluminium - Peinture époxy : Noir - Tube avant 28x1,35mm et tube arrière 25x1,35mm - Textilène 2x2.
Aluminum frame - Black powder coating - Front tube 28x1,35mm and rear tube 25x1,35mm - 2X2 Textilene.



S2
R4



Dauphine

Paris

Chaise - Chair



Noir
Black

Bordeaux & Crème
Bordeaux & Cream

Vert & Crème
Green & Cream



Structure en aluminium - Peinture époxy : Bamboo look foncé - Épaisseur tube 1,5mm - Diamètre tube 28mm - Textilène 8x8.
Aluminum frame - Epoxy powder coating : Dark Bamboo look - Tube thickness 1,5mm - Tube diameter 28mm - Textilene 8x8.



41 56 90 44 3,5



S6
R13,R14,R15



Paris

Montmartre

Fauteuil - *Armchair*



Noir
Black

Structure en aluminium - Peinture époxy : Bamboo look foncé - Épaisseur tube 1,5mm - Diamètre tube 28mm - Textilène 8x8.
Aluminum frame - Epoxy powder coating : Dark Bamboo look - Tube thickness 1,5mm - Tube diameter 28mm - Textilene 8x8.



S6
R13



Montmartre

Drouot

Chaise - Chair



Noir & Gris Clair
Black & Light Grey



Structure aluminium - Peinture époxy : Noir - Épaisseur tube 1,5mm - Diamètre tube 28mm - Textilène 8x8.
Aluminum frame - Black powder coating - Tube thickness 1,5mm - Tube diameter 28mm - 8x8 Textilene.



S2
R11



Drouot

Trocadero

Fauteuil - Armchair



Noir & Gris Clair
Black & Light Grey



Structure aluminium - Peinture époxy : Noir - Épaisseur tube 1,5mm - Diamètre tube 28mm - Textilène 8x8.
Aluminum frame - Black powder coating - Tube thickness 1,5mm - Tube diameter 28mm - 8x8 Textilene.



S2
R11



Trocadero

Bastille

Chaise - Chair



Stock
Limité
Limited
Stock



Anthracite
Anthracite

Olive
Olive

Pimento
Pimento

Stock
Limité
Limited
Stock



ISO 4892-3:2016 

Structure en acier - Peinture époxy - Effet texturé - Épaisseur tube 1,5mm - Diamètre tube 22mm.
Steel frame - Textured Epoxy powder coating - Tube thickness 1,5mm - Tube diameter 22mm.





Bastille

Bastille Bst

Tabouret - Barstool



Anthracite
Anthracite

Olive
Olive

Pimento
Pimento

Stock
Limité
Limited
Stock

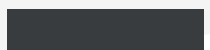

ISO 4892-3:2016

Structure en acier - Peinture époxy - Effet texturé - Épaisseur tube 1,5mm - Diamètre tube 22mm.
Steel frame - Textured Epoxy powder coating - Tube thickness 1,5mm - Tube diameter 22mm.



S7,S8,S9



Bastille Bst

Pigalle

Table - Table

New

Nouveau système basculant
New *fliptop* mechanism

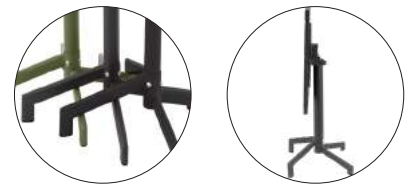

Anthracite
Anthracite

Olive
Olive



2000 cycles

Pied de table en aluminium - Encastrable - Système basculant - Plateau en tôle d'acier - Peinture époxy - Effet texturé.
Aluminum table base - Stackable - *Fliptop* mechanism - Steel sheet table top - Textured Epoxy powder coating.



60x60 42x42 75,5 41x103 8



S7,S9



Pigalle

Pack Bastille & Pigalle

Ensemble - Set



Anthracite
Anthracite

 Pigalle: p62 / Bastille: p58

Ensemble composé de : **1** Table Pigalle - Anthracite + **4** Chaises Bastille - Anthracite.
Set composed of : **1** Pigalle Table - Anthracite + **4** Bastille Chairs - Anthracite.



S7



Pack Bastille & Pigalle

Dubai

New

Chaise - Chair



Taupe
Taupe

Anthracite
Anthracite

Sauge
Sage

Terra
Terra



Voir - See p293

Monobloc polypropylène.
Polypropylene monobloc.



51 57 78 45 4,2



10^{max}



S17,S18, S19,S20



Dubai

Jeddah

New

Fauteuil - *Armchair*



Taupe
Taupe



Anthracite
Anthracite



Sauge
Sage



Terra
Terra



Voir - See p293

Monobloc polypropylène.
Polypropylene monobloc.

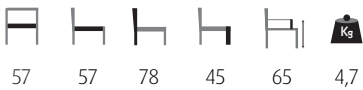

10^{max}



S17,S18, S19,S20



Jeddah

Oman

New

Tabouret - *Barstool*



Taupe
Taupe

Anthracite
Anthracite

Saugé
Saugé

Terra
Terra



Voir - See p293

Monobloc polypropylène.
Polypropylene monobloc.



52 49 104 76 5,3



S17,S18, S19,S20



Oman

Penelope

Chaise - Chair



Noir
Black

Marsala
Marsala



Monobloc polypropylène renforcé avec fibre de verre.
Polypropylene monobloc reinforced with fiberglass.



CATAS

Test report
343113



Penelope

Ulysse

Fauteuil - Armchair



Noir
Black

Marsala
Marsala



Monobloc polypropylène renforcé avec fibre de verre.
Polypropylene monobloc reinforced with fiberglass.



CATAS

Test report
343116



Ulysse

Tom Bar 75

Tabouret - Barstool



Noir
Black

Marsala
Marsala

Olive
Olive



Polypropylène renforcé avec fibre de verre.
Polypropylene reinforced with fiberglass.

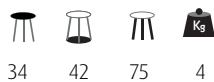

34 42 75 4



CATAS

Test report
344047



Tom Bar 75

Monna

Chaise - Chair



Noir
Black

Olive
Olive

Octane
Octane

Moutarde
Mustard



Monobloc polypropylène renforcé avec fibre de verre.
Polypropylene monobloc reinforced with fiberglass.



CATAS

Test report
276554



Monna

Sky Pro

Fauteuil - *Armchair*



Noir
Black

Olive
Olive



Monobloc polypropylène renforcé avec fibre de verre.
Polypropylene monobloc reinforced with fiberglass.



CATAS

Test report
326232



Sky Pro

Maya

Chaise - Chair



Noir
Black

Olive
Olive

Gris Foncé
Dark Grey

Blanc
White



Monobloc polypropylène.
Polypropylene monobloc.



CATAS

Test report
73610



Maya

Maya Bar 75

Tabouret - Barstool



Noir
Black

Olive
Olive

Gris Foncé
Dark Grey

Blanc
White



Monobloc polypropylène.
Polypropylene monobloc.



CATAS

Test report
236234



Maya Bar 75

Fado

Stock
Limité
Limited
Stock

Fauteuil - *Armchair*



Anthracite
Anthracite

Stock
Limité
Limited
Stock

Monobloc polypropylène.
Polypropylene monobloc.





Fado

Atlantic

Fauteuil - *Armchair*



Noir
Black

Serge Ferrari

Monobloc polypropylène renforcé avec fibre de verre - Textilène Serge Ferrari 2x2.
Polypropylene monobloc reinforced with fiberglass - Serge Ferrari 2x2 Textilene.



CATAS

Test report
308018



Atlantic

Marcel

Chaise - Chair



Noir
Black

Monobloc polypropylène renforcé avec fibre de verre.
Polypropylene monobloc reinforced with fiberglass.



CATAS

Test report
294903



Marcel

Marcel XL

Fauteuil - Armchair



Noir
Black

Monobloc polypropylène renforcé avec fibre de verre.
Polypropylene monobloc reinforced with fiberglass.



CATAS

Test report
294887



Marcel XL

Marcel Bar 75

Tabouret - Barstool



Noir
Black

Polypropylène renforcé avec fibre de verre.
Polypropylene reinforced with fiberglass.



45 52 106 75 4,7



CATAS

Test report
294883



Marcel Bar 75

Daytona

Chaise - Chair



Gris Foncé
Dark Grey

Monobloc polypropylène renforcé avec fibre de verre - Imitation rotin.
Polypropylene monobloc reinforced with fiberglass - Rattan look.

53 60 82 46 3,5



CATAS

Test report
201747



Daytona

Panama

Fauteuil - *Armchair*



Gris Foncé
Dark Grey

Monobloc polypropylène renforcé avec fibre de verre - Imitation rotin.
Polypropylene monobloc reinforced with fiberglass - Rattan look.



CATAS

Test report
201753



Panama

Jamaica

Chaise - Chair



Gris Foncé
Dark Grey

Monobloc polypropylène renforcé avec fibre de verre - Imitation rotin.
Polypropylene monobloc reinforced with fiberglass - Rattan look.



CATAS

Test report
144188



Jamaica

Jamaica F

Fauteuil - *Armchair*



Gris Foncé
Dark Grey

Monobloc polypropylène renforcé avec fibre de verre - Imitation rotin.
Polypropylene monobloc reinforced with fiberglass - Rattan look.



CATAS

Test report
127165



Jamaica F

Jamaica Bst

Tabouret - Barstool



Gris Foncé
Dark Grey

Monobloc polypropylène renforcé avec fibre de verre - Imitation rotin.
Polypropylene monobloc reinforced with fiberglass - Rattan look.



40 51 108 75 6



CATAS

Test report
157230



Jamaica Bst





Kys

Table - Table



Noir
Black

Résine renforcée par une structure métallique - Encastrable - Système basculant - Vérins de réglage.
Resin reinforced by a metallic frame - Stackable - Fliptop mechanism - Adjustable foot plugs.

   
60x60 74 47x100 7,3





Kys



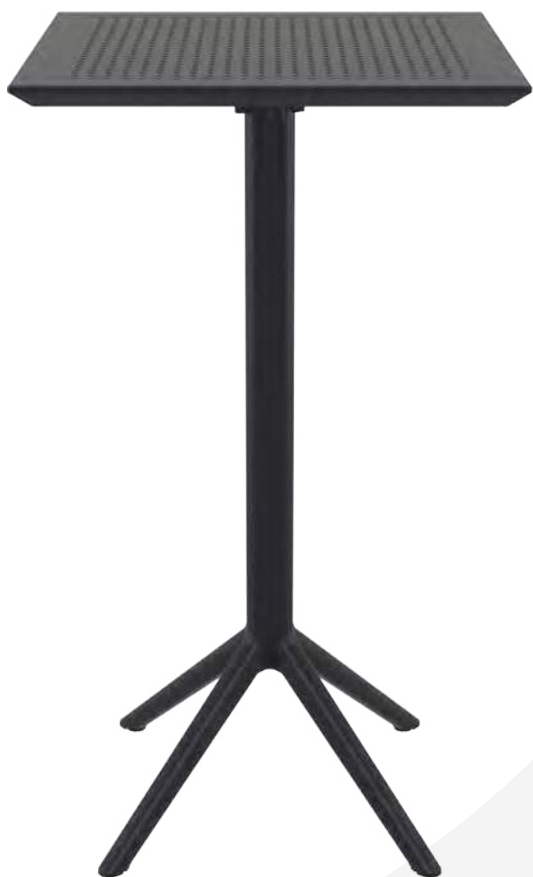

Kys Bar

Table - Table



Noir
Black

Résine renforcée par une structure métallique - Encastrable - Système basculant - Vérins de réglage.
Resin reinforced by a metallic frame - Stackable - Fliptop mechanism - Adjustable foot plugs.

   
60x60 108 47x134 7,5





Kys Bar

Pack Sky Pro & Kys

Ensemble - Set



Noir
Black

 Kys: p106 / Sky Pro: p80

Ensemble composé de : **2** tables Kys - Noir + **4** fauteuils Sky Pro - Noir.
Set composed of : **2** Kys tables - Black + **4** Sky Pro armchairs - Black.



Pack Tom Bar 75 & Kys Bar

Ensemble - Set



Noir
Black

 Kys Bar: p108 / Tom Bar: p76

Ensemble composé de : **2** tables Kys Bar - Noir + **4** tabourets Tom Bar 75 - Noir.
Set composed of : **2** Kys Bar tables - Black + **4** Tom Bar 75 barstools - Black.



Pack Maya & Kys

Ensemble - Set



Noir
Black

 Kys: p106 / Maya: p82

Ensemble composé de : **2** tables Kys - Noir + **4** chaises Maya - Noir.
Set composed of : **2** Kys tables - Black + **4** Maya chairs - Black.



Pack Maya Bar 75 & Kys Bar

Ensemble - Set



Noir
Black

 Kys Bar: p108 / Maya Bar: p84

Ensemble composé de : **2** tables Kys Bar - Noir + **4** tabourets Maya Bar 75 - Noir.
Set composed of : **2** Kys Bar tables - Black + **4** Maya Bar 75 barstools - Black.



Eolo Pureti 250x250cm

Stock
Limité
Limited
Stock

Parasol - Parasol



Anthracite
Anthracite

Stock
Limité
Limited
Stock

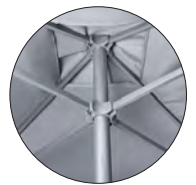

Parasol aluminium laqué avec 4 baleines en aluminium (20x14mm) - Ouverture push-up avec système d'ouverture/fermeture et verrouillage - Tissu Olefin (190gr) qui neutralise par photocatalyse les gaz et substances nocives - **Vendu sans le pied de parasol.**
Lacquered aluminum parasol with 4 aluminum ribs (20x14mm) - Push-up opening with open/close/lock system - Olefin fabric (190gr) neutralizes gases and harmful substances by photocatalysis - **Sold without the parasol base.**

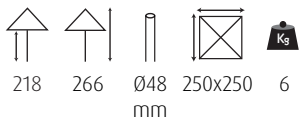



Eolo Pureti

Canto

Stock
Limité
Limited
Stock

Pied de parasol - *Parasol base*



Anthracite
Anthracite



Base carrée en acier, laquée avec peinture en poudre de polyester polymérisée au four - Protections d'angle en acier INOX - Tige filetée au mât du parasol avec languette-frein intérieur pour éviter tout contact direct de la vis avec le mât du parasol - Convient pour le parasol Eolo Pureti 250x250cm.

Steel square base, lacquered with oven-cured polyester powder paint - Stainless steel corner protectors - Threaded rod on the parasol pole with inner locking tabs to prevent direct contact of the screws with the parasol pole - Suitable for the parasol Eolo Pureti 250x250cm.

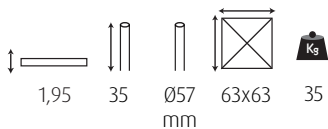



Canto

Verona

Pied de table - *Table base*

Système basculant - *Fliptop mechanism*



Poignée: Facile à porter.
Handle: Easy to carry.



2 crochets pour suspendre les sacs.
2 hooks for hanging bags.



Encastrable: Facile à ranger.
Stackable: Easy to store.



Verona 3 *



Verona Double

Noir
Black

Base et tube en aluminium - Peinture époxy - Système basculant en polyamide - Vérins de réglage.

Aluminium base and tube - Epoxy powder coating - Fliptop mechanism - Adjustable footplugs.



S13

Verona 3 *

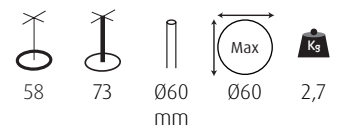

Verona Double

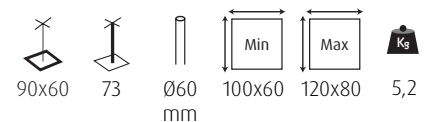

* Modèle déposé
* *Registered design*

Verona

Pied de table - *Table base*

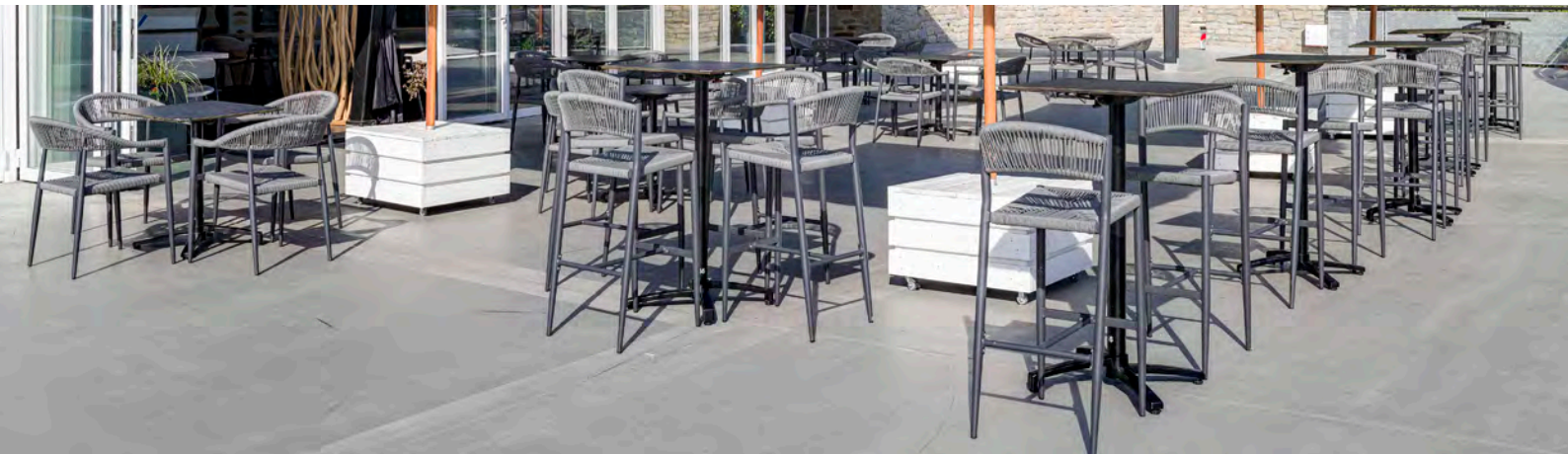

Verona 4



Verona 4 Bar

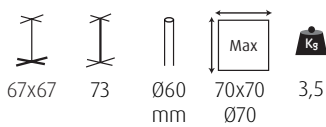

Verona 4

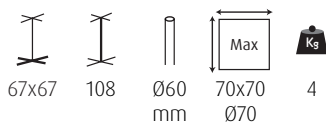

Verona 4 Bar

Base et tube en aluminium - Peinture époxy - Système basculant en polyamide - Vérins de réglage.
Aluminium base and tube - Epoxy powder coating - Fliptop mechanism - Adjustable footplugs.



S10,S11,S13

* Uniquement pour Verona 4.
 * Only for Verona 4.

Monza

Pied de table - Table base



Monza



Monza Bar

Anthracite
Anthracite

Base et tube en aluminium - Peinture époxy - Vérins de réglage.

Aluminium base and tube - Epoxy powder coating - Adjustable footplugs.



S11

Monza

					Contrepoids Extraweight Kg
63x63	73	Ø60 mm	70x70 Ø70	4	1,5

Monza Bar

					Contrepoids Extraweight Kg
63x63	108	Ø60 mm	60x60 Ø70	5,8	3



Monza

Berlin

Pied de table - *Table base*



Berlin 2



Berlin 4

Noir
Black



Base et tube en aluminium - Peinture époxy - Vérins de réglage.

Aluminium base and tube - Epoxy powder coating - Adjustable footplugs.



S13

Berlin 2

60x68	73	Ø60 mm	100x60	120x80	4,5

Berlin 4

					<i>Contrepoids Extravieight</i>
66x66	73	Ø60 mm	80x80 Ø100	6,1	1,5

Berlin

Pied de table - *Table base*



Berlin 4 Bar

Noir
Black



					Contreponds Extraweight Kg
66x66	108	Ø60 mm	70x70 Ø70	6,6	3

Berlin 4 Bar

Base et tube en aluminium - Peinture époxy - Vérins de réglage.
Aluminium base and tube - Epoxy powder coating - Adjustable footplugs.



S13

Empire

Pied de table - Table base



Empire 3



Empire 4



Empire 4 Bar

Noir
Black



Aluminium forgé noir - Vérins de réglage.
Cast aluminum - Powder coated in black - Adjustable footplugs.



S12

Empire 3					4,2
	62	70	60x60 Ø70		
Empire 4					5,3
	60x60	70	70x70 Ø70		
Empire 4 Bar					5,7
	60x60	108	60x60 Ø70		

Empire

Pied de table - *Table base*



Empire 2



Empire Grande

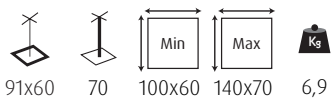

Empire 2

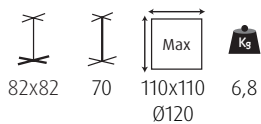

Empire Grande

Noir
Black



Aluminium forgé noir - Vérins de réglage.
Cast aluminum - Powder coated in black - Adjustable footplugs.



S12

Bistrot

Pied de table - *Table base*



Bistrot 3 H43



Bistrot 3

Noir
Black

Fonte d'acier* - Epoxy noir - Vérins de réglage.
Cast iron* - Powder coated in black - Adjustable footplugs.



S15

⚠ *Ces articles peuvent rouiller en utilisation extérieure.
*These items may rust when used outdoor.

Bistrot 3 H43

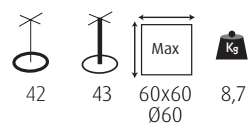

Bistrot 3

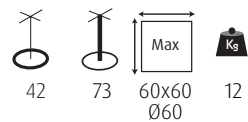

Bistrot

Pied de table - *Table base*



Bistrot 4



Bistrot 3 Bar

Noir
Black

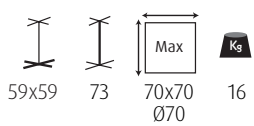

Bistrot 4

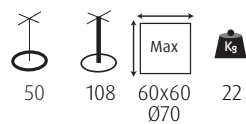

Bistrot 3 Bar

Fonte d'acier* - Epoxy noir - Vérins de réglage.
Cast iron* - Powder coated in black - Adjustable footplugs.



S15

*Ces articles peuvent rouiller en utilisation extérieure. ⚠️
*These items may rust when used outdoor.

Compact Easy 12mm

New

Plateau de table - Table top



Slate
658

New



Corten
406

New

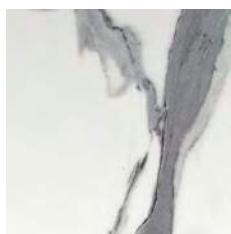

Marmo Bianco
654

New

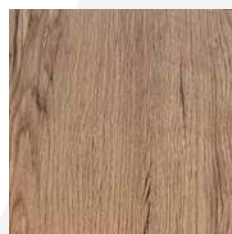

Colorado
459

New

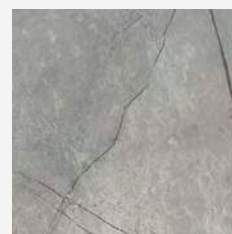

Marmo Griggio
671

New

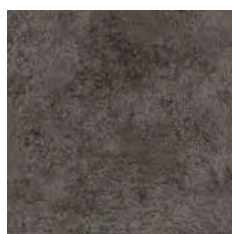

Grafito
918

New

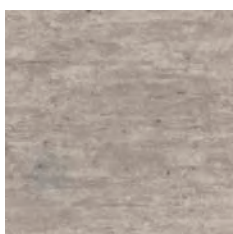

Stone Grey
637

Stock
Limited
Stock

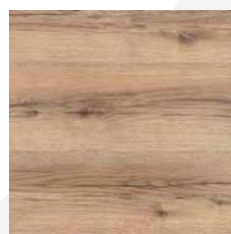

California Oak
679

Stock
Limited
Stock

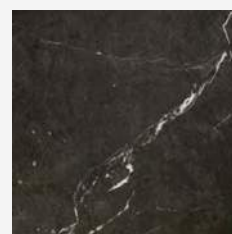

Dark Marble
1541

Stock
Limited
Stock

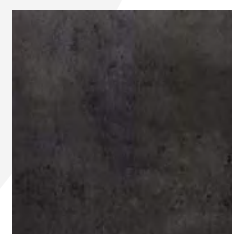

Dark Metal
919

Stock
Limited
Stock

	
cm	65x65
12 mm	5,8kg

Plateau compact 12mm - Chants droits - Système de fixation universel (visserie fournie) - Protection UV.

12mm HPL top - Straight edges - Universal fixing system (screws included) - UV resistant.



Compact
Easy

⚠ Risque de décoloration des couleurs foncées au soleil.
Risk of dark colors fading if sun exposure.



Inserts pour Verona + rails pour autre système de fixation en croix.

Inserts for Verona + grooves for other cross fixing systems.



Compact Easy

Werzalit Classic

New

Plateau de table - *Table top*

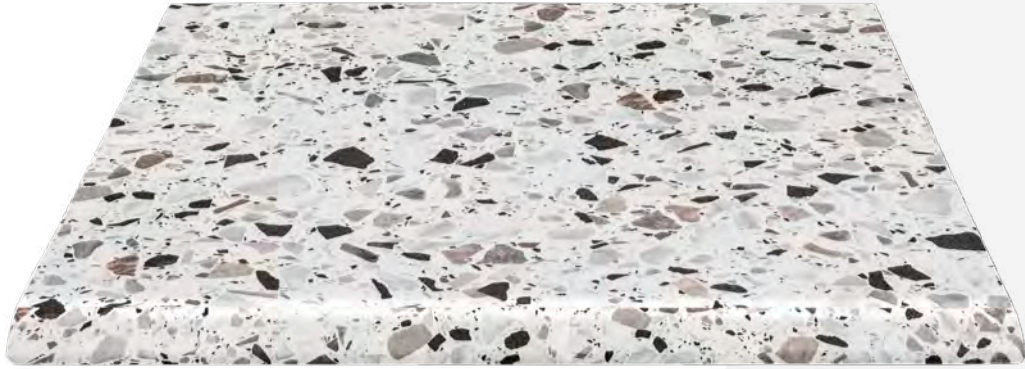

Avalon Pine
4729



New Irony
9687

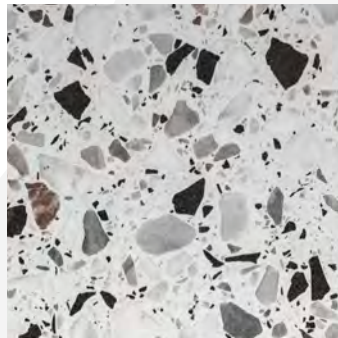

New Malaga
5766

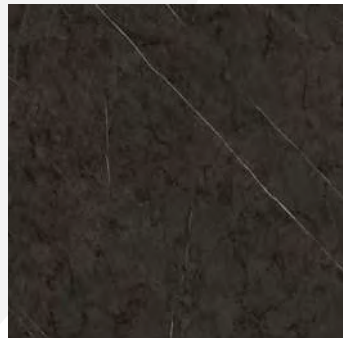

New Grey Marble
5666

	□		○
cm	60x60	70x70	Ø60
32 mm	5,9kg	8kg	5,3kg

Plateau stratifié moulé - Chant 32mm.
Molded laminated top - 32mm edges.



⚠ Risque de décoloration des couleurs foncées au soleil.
Risk of dark colors fading if sun exposure.

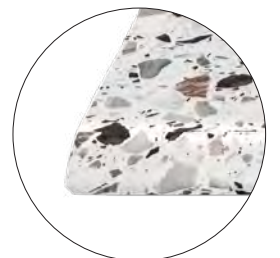



Werzalit Classic

Topalit Classic

Stock
Limité
Limited
Stock

Plateau de table - *Table top*



Veneto
0249



Atacama Cherry
0222

	□	
cm	60x60	70x70
34 mm	5,9kg	8kg

Plateau stratifié moulé - Chant 34mm.

Molded laminated top - 34mm edges.



topaLit
AUSTRALIA

⚠ Risque de décoloration des couleurs foncées au soleil.
Risk of dark colors fading if sun exposure.





Topalit Classic

Werzalit Cerclés

Plateau de table - *Table top*



Marrakesh
5717



Mermer
5410

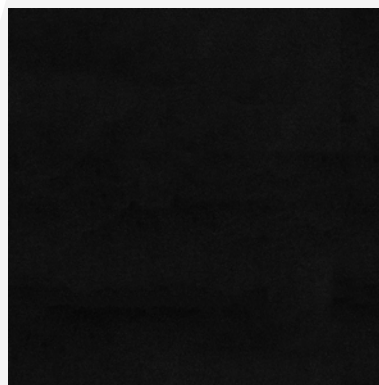

Black Siyah
3190

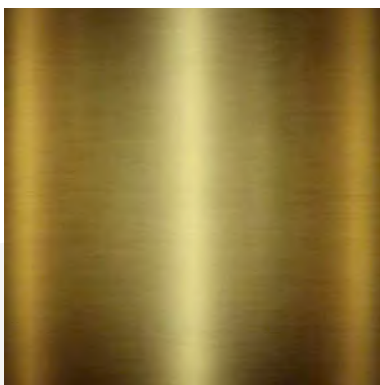

Laiton
Brass

	○
cm	Ø60
30 mm	4,9kg

Plateau stratifié moulé - Cerclage métallique finition laiton - Chant 30mm.
Rimmed table top - Brass finish - 30mm edges.



⚠ Risque de décoloration des couleurs foncées au soleil.
Risk of dark colors fading if sun exposure.





Werzalit Cerclés





Intérieur - Indoor

Simone

New

Chaise - Chair



Terra 59
Terra 59

Vert 39
Green 39

Gris Clair 83
Light Grey 83

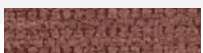

i p296

DAVIS
ARAGON
Aragon

ABRASION TEST
45.000-60.000

BS 5852/0
EN 1021/1



WATER
REPELLENT

Structure en métal noir - Épaisseur tube 1,8mm - Diamètre tube 16mm - Assise et dossier garnis de tissu ARAGON.
Black metal frame - Tube thickness 1,8mm - Tube diameter 16mm - Upholstered seat and back with ARAGON fabric.





Simone

René

New

Fauteuil - Armchair



Terra 59
Terra 59



Vert 39
Green 39



Gris Clair 83
Light Grey 83



i p296

DAVIS
ARAGON
Aragon

ABRASION TEST
45.000-60.000

BS 5852/0
EN 1021/1



Structure en métal noir - Épaisseur tube 1,8mm - Diamètre tube 16mm - Assise et dossier garnis de tissu ARAGON.
Black metal frame - Tube thickness 1,8mm - Tube diameter 16mm - Upholstered seat and back with ARAGON fabric.





René

Auguste

New

Tabouret - Barstool



Terra 59
Terra 59

Vert 39
Green 39

Gris Clair 83
Light Grey 83



i p296

DAVIS
ARAGON

ABRASION TEST
45.000-60.000

BS 5852/0
EN 1021/1



Structure en métal noir - Épaisseur tube 2mm - Diamètre tube 19mm - Assise et dossier garnis de tissu ARAGON.
Black metal frame - Tube thickness 2mm - Tube diameter 19mm - Upholstered seat and back with ARAGON fabric.



51 55 108 78 8,4





Auguste

Mélina

New

Chaise - Chair



Gris 18
Grey 18

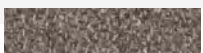

 p296

DAVIS
FABRICA
Gava

ABRASION TEST
90.000-100.000

BS 5852/0
EN 1021/1

WATER
REPELLENT

RECYCLED
POLYESTER

Structure en métal noir - Épaisseur tube 1,5mm - Diamètre tube 19mm - Assise et dossier garnis de tissu GAVA.
Black metal frame - Tube thickness 1,5mm - Tube diameter 19mm - Upholstered seat and back with GAVA fabric.

    
55 58 75 48 5,4





Mélina

Sandra

New

Tabouret - Barstool



Gris 18
Grey 18



 p296

DAVIS
Gava

ABRASION TEST
90.000-100.000

BS 5852/0
EN 1021/1

WATER
REPELLENT

RECYCLED
POLYESTER

Structure en métal noir - Épaisseur tube 1,5mm - Diamètre tube 19mm - Assise et dossier garnis de tissu GAVA.
Black metal frame - Tube thickness 1,5mm - Tube diameter 19mm - Upholstered seat and back with GAVA fabric.

    
53 56 104 79 6





Sandra

Noëlia

New

Chaise - Chair



Gris 10/Noir
Grey 10/Black



 p298

ABRASION TEST
30.000

fab
Brego

Structure en métal noir - Épaisseur tube: dossier 1,8mm/pieds 2,5mm - Diamètre tube 16mm - Assise garnie de tissu BREGO - Dossier en contre-plaqué, garni en PVC imitation cannage naturel.

Black metal frame - Tube thickness: back 1,8mm/legs 2,5mm - Diameter tube 16mm - Seat upholstered in BREGO fabric - Plywood backrest with PVC imitation natural caning.





Noëlia

Zoé

New

Chaise - Chair

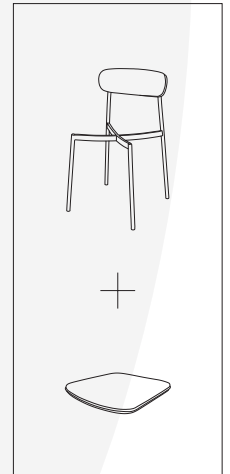

STRUCTURE - FRAME

Noir & Bois Naturel
Black & Natural Wood



Blanc & Bois Naturel
White & Natural Wood

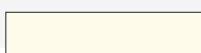

ASSISE - SEAT

Gris Brun 056
Grey Brown 056



Olive 144
Olive 144



Orange 106
Orange 106



Beige 032
Beige 032



i p298

ote miss
Miss

ABRASION TEST
>40.000

Structure en métal - Épaisseur tube 2mm - Diamètre tube 19mm - Assise en contre-plaqué, garnie de tissu MISS, dossier en contre-plaqué.

Metal frame - Tube thickness 2mm - Tube diameter 19mm - Plywood seat upholstered in MISS fabric, plywood back.





Zoé

Ralph

New

Tabouret - Barstool

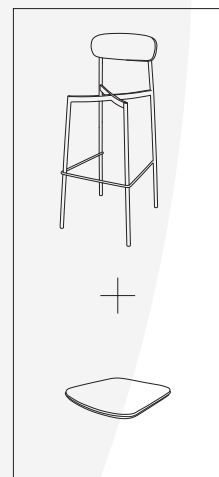

STRUCTURE - FRAME

Noir & Bois Naturel
Black & Natural Wood



Blanc & Bois Naturel
White & Natural Wood

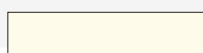

ASSISE - SEAT

Gris Brun 056
Grey Brown 056



Olive 144
Olive 144



Orange 106
Orange 106



Beige 032
Beige 032



p298

ote
Miss

ABRASION TEST
>40.000

Structure en métal - Épaisseur tube 2mm - Diamètre tube 19mm - Assise en contre-plaqué, garnie de tissu MISS, dossier en contre-plaqué.

Metal frame - Tube thickness 2mm - Tube diameter 19mm - Plywood seat upholstered in MISS fabric, plywood back.



42 48 106 78 6,8





Ralph

Paulette

New

Chaufeuse - Lounge chair



Grace Tempete 77
Cloud Orage 97
Grace Tempest 77
Cloud Storm 97

Grace Corde 16
Cloud Pierre 87
Grace Rope 16
Cloud Stone 87



 p297

DAVIS
Grace
Cloud

ABRASION TEST
Cloud 90-100.000
Grace 60-70.000

EN 1021/1

RECYCLED
POLYESTER
Grace

EASY
CLEAN

Structure en hêtre teinté noir - Assise et dos garnis en bi-tissus.
Beech frame black stained - Bi-fabric upholstered seat and back.

    
70 72 78 43 14.2

  
FSC



Paulette

Colette

Chaise - Chair



Grace Tempete 77
 Cloud Orage 97
 Grace Tempest 77
 Cloud Storm 97

Grace Corde 16
 Cloud Pierre 87
 Grace Rope 16
 Cloud Stone 87



 p297

DAVIS
 Grace
 Cloud

ABRASION TEST
 Cloud 90-100.000
 Grace 60-70.000

 EN 1021/1

 RECYCLED
 POLYESTER
 Grace

 EASY
 CLEAN

Structure en hêtre teinté noir - Assise et dos garnis en bi-tissus.
 Beech frame black stained - Bi-fabric upholstered seat and back.





Colette

Adèle

Chaise - Chair



Grace Tempete 77
Cloud Orage 97
Grace Tempest 77
Cloud Storm 97

Grace Corde 16
Cloud Pierre 87
Grace Rope 16
Cloud Stone 87



 p297

DAVIS
ABRASION TEST
Grace
Cloud

Cloud 90-100.000
Grace 60-70.000

EN 1021/1

RECYCLED
POLYESTER
Grace

EASY
CLEAN

Structure en hêtre teinté noir - Assise et dos garnis en bi-tissus.
Beech frame black stained - Bi-fabric upholstered seat and back.





Adèle

Victoire Bst

Tabouret - Barstool



Grace Tempete 77
Cloud Orage 97
Grace Tempest 77
Cloud Storm 97

Grace Corde 16
Cloud Pierre 87
Grace Rope 16
Cloud Stone 87

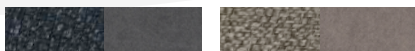

 p297

DAVIS
GRACE
Grace
Cloud

ABRASION TEST
Cloud 90-100.000
Grace 60-70.000

 EN 1021/1

 RECYCLED
POLYESTER
Grace

 EASY
CLEAN

Structure en hêtre teinté noir - Assise et dos garnis en bi-tissus - Repose-pieds en hêtre avec renfort métallique.
Beech frame black stained - Bi-fabric upholstered seat and back - Beech footrest with metal reinforcement.

     Kg
52 57 105 77 8,5

   FSC



Victoire Bst

Mikka

New

Chaise - Chair



Cuoio
Cuoio

Anthracite
Anthracite



 p298

 **elastron**
COLORADO

ABRASION TEST
100.000

 **BS 5852/0**
EN 1021/1



Structure en métal noir - Épaisseur tube 1,5mm - Diamètre tube 32mm - Assise et dossier garnis de similicuir PU COLORADO.
Black metal frame - Tube thickness 1,5mm - Tube diameter 32mm - Seat and back upholstered in COLORADO PU faux-leather.

     
56 60 81 48 7,4





PIADA

The Italian Wrap is a thin Italian Flatbread typically prepared in the Romagna Region. It is usually made with white flour, lard (or olive oil), salt & water.

- parma, soft cheese, rocket
- cooked ham, tomato, mozzarella 4.00
- salami milano, soft cheese, rocket
- tuna, mayo, tomato, salad
- italian sausage, onions, red peppers 4.50
- soft cheese, rocket 3.50
- nutella 3.00

WINE LIST

	Glass	Bottle
COL ERENCO PINOT GRIGIO Italy 2015	8.00	28.00
GRAHAM LEX CHENIN BLANC South Africa 2017	7.50	27.00
WILLETTS HILL VIOGATIER California Valley 2019	9.50	30.00
COLESON DE CLESSE France 2018	7.50	25.00
KUNG FU GRIERLING Washington State	9.50	33.00
ARCHERY SUMMIT PREMIER CUVEE PINOT NOIR Willamette Valley 2016	10.50	88.00
BOIRA SANGIOVESE Marche, Italy 2018	7.00	30.00
BRANDBOG BENCH LANDS PINOT NOIR Umpqua Valley, Oregon 2016	8.00	42.25
CHATEAUNEUF-DU-PAPE DOMAINE LUCIEN BARROT Rhône 2016	9.00	48.00

Mikka

Olaf

Fauteuil - Armchair

New



Cuoio
Cuoio

Anthracite
Anthracite



p298

elastron
COLORADO

ABRASION TEST
100.000

BS 5852/0
EN 1021/1



Structure en métal noir - Épaisseur tube 1,5mm - Diamètre tube 32mm - Assise et dossier garnis de similicuir PU COLORADO.
Black metal frame - Tube thickness 1,5mm - Tube diameter 32mm - Seat and back upholstered in COLORADO PU faux-leather.

Kg
57 59 87 48 66 6,8





Olaf

Jacob

New

Chaise - Chair



Cuoio
Cuoio

Anthracite
Anthracite



p298

elastron
COLORADO

ABRASION TEST
100.000

BS 5852/0
EN 1021/1



Structure en métal noir - Épaisseur tube 1,5mm - Tube 15x30mm - Assise et dossier garnis de similicuir PU COLORADO.
Black metal frame - Tube thickness 1,5mm - Tube 15x30mm - Seat and back upholstered in COLORADO PU faux-leather.





Jacob



Kyle

Wendy

New

Banquette - Bench



Connecteur amovible inclus
Removable connector included



Cuoio
Cuoio

Anthracite
Anthracite

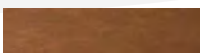

 p298

 **elastron**
COLORADO

ABRASION TEST
100.000

 **BS 5852/0**
EN 1021/1



Structure en métal noir - Épaisseur tube 1,5mm - Tube 30x30mm - Assise et dossier garnis de similicuir PU COLORADO.
Black metal frame - Tube thickness 1,5mm - Tube 30x30mm - Seat and back upholstered in COLORADO PU faux-leather.

120 60 94 48 30





Wendy

Maurice

Chaise - Chair



Cognac
Cognac

Anthracite
Anthracite



EN 1021/1

Structure métallique noire - Épaisseur tube 1,5mm - Diamètre tube 28mm - Assise et dos garnis en similicuir PU.
Black metal frame - Tube thickness 1,5mm - Tube diameter 28mm - Seat and back upholstered with PU faux-leather.

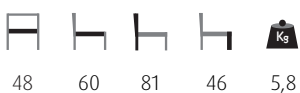



Maurice

Maurice Bst

Tabouret - Barstool



Maurice Bst H65



Maurice Bst H79

Cognac
Cognac



Anthracite
Anthracite



EN 1021/1

Structure métallique noire - Épaisseur tube 1,5mm - Diamètre tube 28mm - Assise et dos garnis en similicuir PU.
Black metal frame - Tube thickness 1,5mm - Tube diameter 28mm - Seat and back upholstered with PU faux-leather.



Maurice Bst H65



Maurice Bst H79





Maurice Bst

College

New

Chaise - Chair



Teinte Brun «Vintage»
«Vintage Brown» Stain



Structure en métal finition industrielle, vernis brillant - Épaisseur tube 1,5mm - Diamètre tube 25mm - Assise et dossier en contre-plaqué.

Metal frame, industrial finish, glossy varnish - Tube thickness 1,5mm - Tube diameter 25mm - Seat and back in plywood.



44 53 80 47 4,8



6max



College

Montreal

New

Fauteuil - Armchair



Marron Vintage
Vintage Brown



Structure en métal noir - Épaisseur tube 40x20x1,2mm - Assise et dossier garnis de similicuir PU.
Black metal frame - Tube thickness 40x20x1,2mm - Seat and back upholstered with PU faux-leather.



52 55 77 46 68 7,5





Montreal

Stanley

Chaise - Chair



Marron Vintage
Marron Vintage

Structure métallique noire - Épaisseur tube 1,5mm - Diamètre tube 19mm - Assise et dos garnis en similicuir PU.
Black metal frame - Tube thickness 1,5mm - Tube diameter 19mm - Seat and back upholstered with PU faux-leather.





Stanley

Stanley Bst

Tabouret - Barstool



Marron Vintage
Marron Vintage



Structure métallique noire - Épaisseur tube 1,5mm - Diamètre tube 19mm - Assise et dos garnis en similicuir PU.
Black metal frame - Tube thickness 1,5mm - Tube diameter 19mm - Seat and back upholstered with PU faux-leather.





Stanley Bst

Brixton

Fauteuil - *Armchair*



Marron Vintage
Vintage Brown



Structure métallique noire - Accoudoirs en bois - Épaisseur tube 2mm - Diamètre tube 28mm - Assise et dos garnis en similicuir PU.

Black metal frame - Wooden armrests - Tube thickness 2mm - Tube diameter 28mm - Seat and back upholstered with PU faux-leather.

A H H H H |  Kg
65 78 91 44 65 18,5





Brixton

Soho

Chaise - Chair



Cognac Vintage
Cognac Vintage



Structure métallique noire - Épaisseur tube 1,5mm - Diamètre tube 30mm - Assise et dos garnis en similicuir PU.
Black metal frame - Tube thickness 1,5mm - Tube diameter 30mm - Seat and back upholstered with PU faux-leather.





Soho

Alex

Stock
Limité
Limited
Stock

Chaise - Chair



Noir
Black

Stock
Limité
Limited
Stock

Structure métallique noire - Épaisseur tube 1,5mm - Diamètre tube 22mm - Assise et dos garnis en similicuir PU.
Black metal frame - Tube thickness 1,5mm - Tube diameter 22mm - Seat and back upholstered with PU faux-leather.





Alex

Barossa

Stock
Limité
Limited
Stock

Chaise - Chair



Cognac
Cognac

Stock
Limité
Limited
Stock



 p299

Structure métallique noire - Épaisseur tube 1,2mm - Diamètre tube 32mm - Assise et dos garnis en similicuir PU VICTORY.
Black metal frame - Tube thickness 1,2mm - Tube diameter 32mm - Seat and back upholstered with VICTORY PU faux-leather.

     
48 65 87 49 6,3





Barossa

Condor

Stock
Limité
Limited
Stock

Fauteuil - *Armchair*



Cognac
Cognac

Stock
Limité
Limited
Stock

Anthracite
Anthracite

Stock
Limité
Limited
Stock



 p299

Structure métallique noire (en une pièce) - Épaisseur tube 1,2mm - Tube 20x20mm - Assise et dos garnis de tissu SOFTYL.
Black metal frame (in one piece) - Tube thickness 1,2mm - Tube 20x20mm - Seat and back upholstered with SOFTYL fabric.

     
51 62 91 48 65 9





Condor

Pickup

Stock
Limité
Limited
Stock

Chaise - Chair



Cognac
Cognac

Stock
Limité
Limited
Stock



 p298

Structure métallique noire - Épaisseur tube 1,2mm - Tube 25x25mm - Assise et dos garnis de tissu LUXOR.
Black metal frame - Tube thickness 1,2mm - Tube 25x25mm - Seat and back upholstered with LUXOR fabric.

    
48 59 88 48 8





Pickup

Cuba

Fauteuil - *Armchair*



Brun Clair 41
Light Brown 41



 p298

fab[®]
Cortes

ABRASION TEST
35.000

Structure en hêtre teinté Wengé - Assise et dos garnis de tissu Vintage CORTES.
Beech frame Wenge stained - Seat and back upholstered with CORTES fabric.

72 69 70 43 67 16,8





Cuba

Cuba Double

Fauteuil - *Armchair*



Brun Clair 41
Light Brown 41



 p298

fabb
Cortes

ABRASION TEST
35.000

Structure en hêtre teinté Wengé - Assise et dos garnis de tissu Vintage CORTES.
Beech frame Wenge stained - Seat and back upholstered with CORTES fabric.

119 69 70 43 67 22,3





Cuba Double

Kate

New

Chaise - Chair

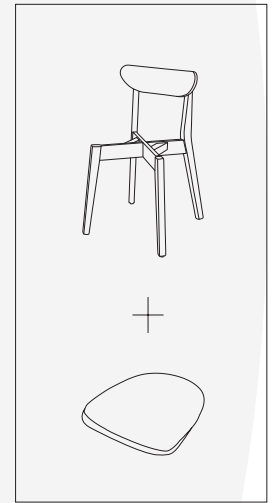

STRUCTURE - FRAME

Teinte Chêne Miel
Honey Oak Stain

Noir
Black

ASSISE - SEAT

Rouille 52
Rusty 52

Vert 34
Green 34

Gris 90
Grey 90

Bleu 75
Blue 75

p297

DAVIS
FABRICS
Luis

ABRASION TEST
30.000

EN 1021/1

WATER REPELLENT

Structure en hêtre teinté - Assise garnie de tissu LUIS.
Stained beech frame - Upholstered seat with LUIS fabric.

44 48 76 49 5,1

Dimension compacte
Compact size



Kate

Budapest

Chaise - Chair

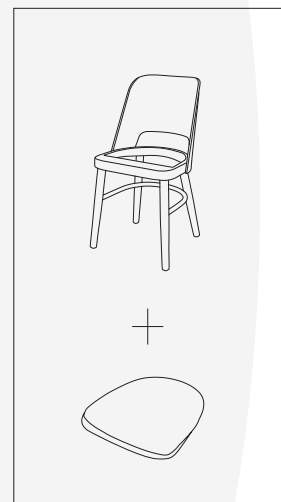

STRUCTURE - FRAME

Teinte Chêne Miel
Honey Oak Stain



Teinte Wengé
Wenge Stain

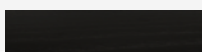

ASSISE - SEAT

Bordeaux 5269
Bordeaux 5269



Éléphant 5272
Elephant 5272



Cappuccino 5582
Cappuccino 5582



Terra 9244
Terra 9244



Olive 9430
Olive 9430



Noir 7006
Black 7006



p299

TEXTUM ABRASION TEST
Lotos >100.000

Structure en hêtre teinté - Assise garnie de similicuir PU LOTOS.
Stained beech frame - Upholstered seat with LOTOS PU faux-leather.

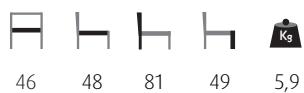



Budapest

Budapest Bst

Tabouret - Barstool

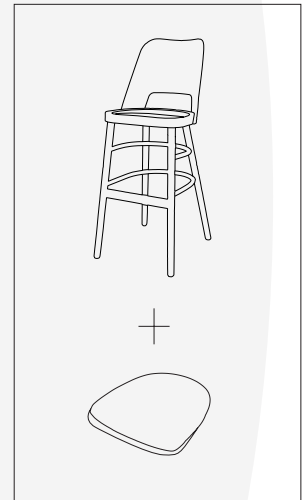

STRUCTURE - FRAME

Teinte Chêne Miel
Honey Oak Stain



Teinte Wengé
Wenge Stain

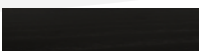

ASSISE - SEAT

Bordeaux 5269
Bordeaux 5269

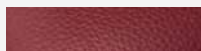

Éléphant 5272
Elephant 5272

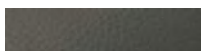

Cappuccino 5582
Cappuccino 5582



Terra 9244
Terra 9244



Olive 9430
Olive 9430

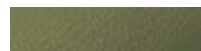

Noir 7006
Black 7006



p299

ABRASION TEST
Lotos >100.000

Structure en hêtre teinté - Assise garnie de similicuir PU LOTOS - Repose-pieds en hêtre avec renfort métallique.
Stained beech frame - Upholstered seat with LOTOS PU faux-leather - Beech footrest with metal reinforcement.





Budapest Bst

Dimitri

Chaise - Chair

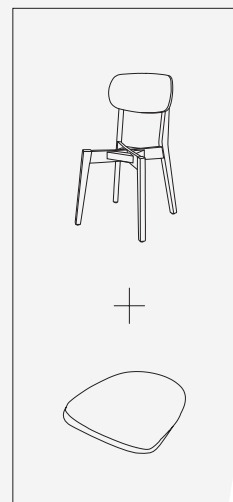

STRUCTURE - FRAME

Teinte Chêne Miel
Honey Oak Stain



ASSISE - SEAT

Noir 7006
Black 7006



 p299

 **ABRASION TEST**
Lotos >100.000

Structure en hêtre teinté - Assise garnie de similicuir PU LOTOS.
Stained beech frame - Upholstered seat with LOTOS PU faux-leather.





Dimitri

Dimitri Bst

Tabouret - Barstool

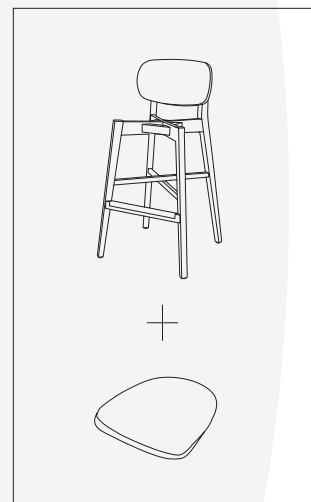

STRUCTURE - FRAME

Teinte Chêne Miel
Honey Oak Stain



ASSISE - SEAT

Noir 7006
Black 7006



 p299

 **TEXTUM** ABRASION TEST
Lotos >100.000

Structure en hêtre teinté - Assise garnie de similicuir PU LOTOS - Repose-pieds en hêtre avec renfort métallique.
Stained beech frame - Upholstered seat with LOTOS PU faux-leather - Beech footrest with metal reinforcement.

     
50 49 102 77 7,4





Dimitri Bst

Brooklyn

Chaise - Chair

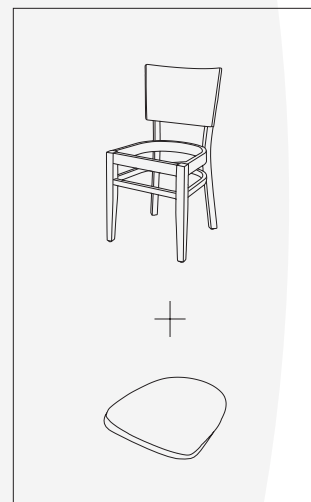

STRUCTURE - FRAME

Teinte Wengé
Wenge Stain

Bordeaux 5269
Bordeaux 5269



ASSISE - SEAT

Chocolat 9314
Chocolate 9314



Cappuccino 5582
Cappuccino 5582



Noir 7006
Black 7006



p299

ABRASION TEST
Lotos >100.000

Structure en hêtre teinté - Assise garnie de similicuir PU LOTOS.
Beech frame Wenge stained - Upholstered seat with LOTOS PU faux-leather.





Brooklyn

Brooklyn Bst

Tabouret - Barstool

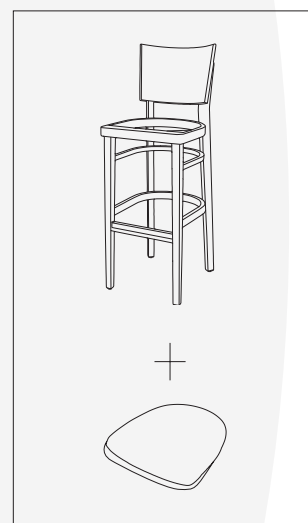

STRUCTURE - FRAME

Teinte Wengé
Wenge Stain

Bordeaux 5269
Bordeaux 5269



ASSISE - SEAT

Chocolat 9314
Chocolate 9314



Cappuccino 5582
Cappuccino 5582



Noir 7006
Black 7006



i p299

TEKUM ABRASION TEST
Lotos >100.000

Structure en hêtre teinté - Assise garnie de similicuir PU LOTOS - Repose-pieds en hêtre avec renfort métallique noir.
Beech frame Wenge stained - Upholstered seat with LOTOS PU faux-leather - Beech footrest with black metal reinforcement.



44 53 109 79 10,9





Brooklyn Bst

Pub

Chaise - Chair

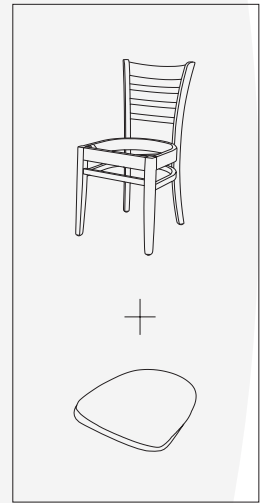

STRUCTURE - FRAME

Teinte Wengé
Wenge Stain

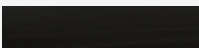

Bordeaux 5269
Bordeaux 5269



Cappuccino 5582
Cappuccino 5582



ASSISE - SEAT

Chocolat 9314
Chocolate 9314



Noir 7006
Black 7006



p299

ABRASION TEST
Lotos >100.000

Structure en hêtre teinté - Assise garnie de similicuir PU LOTOS.
Beech frame Wenge stained - Upholstered seat with LOTOS PU faux-leather.



43 53 85 47 6,9





Pub



Pub Bst

Sofia

Chaise - Chair



Noir
Black

Brun Foncé
Dark Brown

French Patina
French Patina

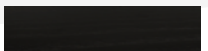

Structure en hêtre teinté .
Stained beech frame.



46 45 87 47 4





Sofia

Sofia Bst

Tabouret - Barstool



Noir
Black

Brun Foncé
Dark Brown

French Patina
French Patina



Structure en hêtre teinté .
Stained beech frame.



46 45 108 76 5,3





Sofia Bst

Maurice

Chaise - Chair



Burgundy 69
Burgundy 69



Petrol 76
Petrol 76



Olive 38
Olive 38



p297

DAVIS
FABRICS
Monolith

ABRASION TEST
90.000-100.000

EN 1021/1

WATER REPELLENT

Structure métallique noire - Épaisseur tube 1,5mm - Diamètre tube 25mm - Assise et dossier garnis de velours MONOLITH - Passepoil noir.

Black metal frame - Tube thickness 1,5mm - Tube diameter 25mm - Seat and back upholstered with MONOLITH velvet - Black piping.



48 60 81 46 5,7





Maurice

Maurice Bst

Tabouret - Barstool



Burgundy 69
Burgundy 69

Petrol 76
Petrol 76

Olive 38
Olive 38



 p297

DAVIS
Monolith

ABRASION TEST
90.000-100.000

EN 1021/1

WATER
REPELLENT

Structure métallique noire - Épaisseur tube 1,5mm - Diamètre tube 22mm - Assise et dossier garnis de velours MONOLITH - Passepoil noir.

Black metal frame - Tube thickness 1,5mm - Tube diameter 22mm - Seat and back upholstered with MONOLITH velvet - Black piping.



37 54 107 79 6,3





Maurice Bst

Emile

Chaise - Chair



Anthracite 92
Anthracite 92

Petrol 76
Petrol 76

Olive 38
Olive 38

Gold 48
Gold 48

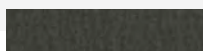

DAVIS
FABRIC
Monolith

ABRASION TEST
90.000-100.000

EN 1021/1

WATER
REPELLENT

Structure en hêtre teinté noir - Assise et dossier garnis de velours MONOLITH.
Beech frame black stained - Seat and back upholstered with MONOLITH velvet.



49 55 81 49 6





Emile

Alfonse

Fauteuil - *Armchair*



Anthracite 92
Anthracite 92

Petrol 76
Petrol 76

Olive 38
Olive 38

Gold 48
Gold 48

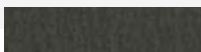

DAVIS
FABRICS
Monolith

ABRASION TEST
90.000-100.000

EN 1021/1



Structure en hêtre teinté noir - Assise et dossier garnis de velours MONOLITH.
Beech frame black stained - Seat and back upholstered with MONOLITH velvet.





Alfonse

Oscar Bst

Tabouret - Barstool



Anthracite 92
Anthracite 92

Petrol 76
Petrol 76

Olive 38
Olive 38

Gold 48
Gold 48



DAVIS
FABRICS
Monolith

ABRASION TEST
90.000-100.000

EN 1021/1

WATER REPELLENT

Structure en hêtre teinté noir - Assise et dos garnis de velours MONOLITH - Repose-pieds en hêtre avec renfort métallique.
Beech frame black stained - Seat and back upholstered with MONOLITH velvet - Beech footrest with metal reinforcement.



52 57 105 77 9





Oscar Bst

Lautrec S

Chaqueuse - Lounge Chair



Anthracite 92
Anthracite 92

Petrol 76
Petrol 76

Olive 38
Olive 38

Gold 48
Gold 48



DAVIS
LABORATORIE
Monolith

ABRASION TEST
90.000-100.000

EN 1021/1



Structure en hêtre teinté noir - Assise et dossier garnis de velours MONOLITH.
Beech frame black stained - Seat and back upholstered with MONOLITH velvet.





Lautrec S

Arnold

Fauteuil - *Armchair*



Anthracite 92
Anthracite 92

Petrol 76
Petrol 76

Gold 48
Gold 48



DAVIS
Monolith

ABRASION TEST
90.000-100.000

EN 1021/1



Structure en hêtre - Pieds métalliques noirs - Assise et dossier garnis de velours MONOLITH.
Beech frame - Black metal legs - Seat and back upholstered with MONOLITH velvet.



4 pieds à visser
4 legs to be mounted



Arnold

Willy

Fauteuil - *Armchair*



Anthracite 92
Anthracite 92

Petrol 76
Petrol 76

Gold 48
Gold 48



 p297

DAVIS
FABRICS
Monolith

ABRASION TEST
90.000-100.000

EN 1021/1

WATER
REPELLENT

Structure en hêtre - Pieds métalliques noirs - Assise et dossier garnis de velours MONOLITH.
Beech frame - Black metal legs - Seat and back upholstered with MONOLITH velvet.

140 84 83 49 64 39

4 pieds à visser
4 legs to be mounted



Willy

Floriane II

New

Chaise - Chair



Taupe 926
Taupe 926

Chocolat 928
Chocolate 928

Noir 9100
Black 9100

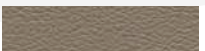

 p299

Structure en hêtre teinté Wengé - Assise et dossier garnis de similicuir PU.
Beech frame Wenge stained - Seat and back upholstered with PU faux-leather.

     
45 54 84 50 7,5





Floriane II

Floriane Bst II

New

Tabouret - Barstool



Taupe 926
Taupe 926

Chocolat 928
Chocolate 928

Noir 9100
Black 9100



 p299

Structure en hêtre teinté Wengé - Assise et dossier garnis de similicuir PU - Repose-pieds en métal.
Beech frame Wengé stained - Seat and back upholstered with PU faux-leather - Metal footrest.

45 54 111 78 8,5





Floriane Bst II

Clinton

Chaise - Chair



Naturel & Elephant 5272 Wengé & Noir 7006 Wengé & Pepper 5271
Natural & Elephant 5272 Black & Wenge 7006 Pepper & Wenge 5271

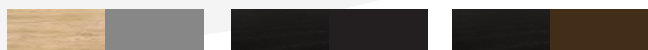

 p299  **ABRASION TEST**
Lotos >100.000

Structure en hêtre teinté - Assise et dos garnis de similicuir PU LOTOS.
Stained beech frame - Seat and back upholstered with LOTOS PU faux-leather.

    
44 59 89 50 5,8





Clinton

Clinton Bst

Tabouret - Barstool



Naturel & Elephant 5272 Wengé & Noir 7006 Wengé & Pepper 5271
Natural & Elephant 5272 Black & Wenge 7006 Pepper & Wenge 5271



 p299

 TEXTUM
Lotos

ABRASION TEST
>100.000

Structure en hêtre teinté - Assise et dossier garnis de similicuir PU LOTOS - Repose-pieds en métal.
Stained beech frame - Seat and back upholstered with LOTOS PU faux-leather - Metal footrest.



36 44 100 81 7





Clinton Bst

Maryne

New

Table basse - *Low table*



Marbre noir
Black marble

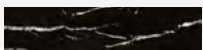

Lot de 2 tables - Structure métallique noire - Épaisseur tube 1,5mm - Diamètre tube 25mm - Plateau mélaminé.
Set of 2 tables - Black metal frame - Tube thickness 1,5mm - Tube diameter 25mm - Melamine top.



Grande/Big A: 90 / B: 80
Petite/Small A: 69 / B: 62



Grande/Big: 37
Petite/Small: 30



Grande/Big: 8,3
Petite/Small: 5,3





Maryne

Jolyne

New

Table basse - *Low table*



Noir
Black

Mango
Mango

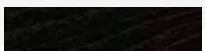

Structure métallique noire - Epaisseur de tube 1,5mm - Tube 15x60mm - Plateau mélaminé - Patins réglables.
Black metal frame - Tube thickness 1,5mm - Tube 15x60mm - Melamine top - Adjustable footplugs.

  
60 42 9,5





Jolyne

Ellen

Table basse - *Low table*



Naturel
Natural



Structure métallique noire - Épaisseur tube 1,2mm - Tube 60x15mm - Plateau mélaminé - Patins réglables.
Black metal frame - Tube thickness 1,2mm - Tube 60x15mm - Melamine top - Adjustable footplugs.

  
60 43 11,7





Ellen

Factory

Pied de table - *Table base*

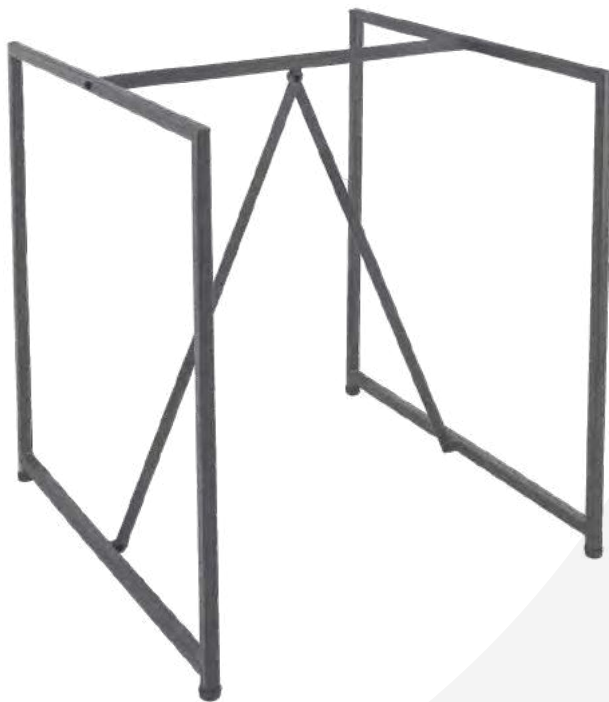

Gun Métal
Gun Metal

Structure métallique - Tube 20x20mm - Épaisseur 2mm -
Vérins réglables.

*Metal frame - Tube size 20x20mm - Tube thickness 2mm -
Adjustable footplugs.*



Factory 70

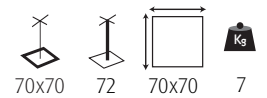

Retro

Pied de table - *Table base*



Retro Small



Retro Large

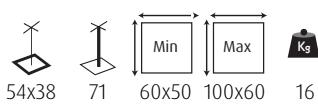

Retro Small

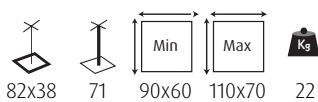

Retro Large

Noir
Black



Fonte d'acier - Epoxy noir - Vérins de réglage.
Cast iron - Powder coated in black - Adjustable footplugs.



S15

Bistrot

Pied de table - Table base



Bistrot 3 H43



Bistrot 3

Noir
Black

Fonte d'acier* - Epoxy noir - Vérins de réglage.
Cast iron* - Powder coated in black - Adjustable footplugs.



S15

⚠ *Ces articles peuvent rouiller en utilisation extérieure.
*These items may rust when used outdoor.

Bistrot 3 H43

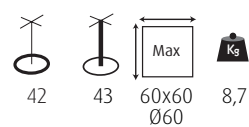

Bistrot 3

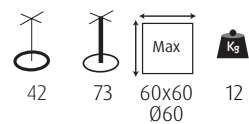

Bistrot

Pied de table - *Table base*



Bistrot 4



Bistrot 3 Bar

Noir
Black

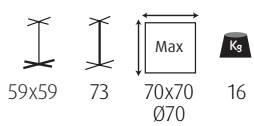

Bistrot 4

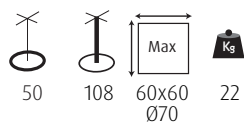

Bistrot 3 Bar

Fonte d'acier* - Epoxy noir - Vérins de réglage.
Cast iron* - Powder coated in black - Adjustable footplugs.



S15

*Ces articles peuvent rouiller en utilisation extérieure. ⚠
*These items may rust when used outdoor.

Prato

Pied de table - Table base



Prato 16



Prato 19



Prato 30

Noir
Black

Fonte d'acier - Epoxy noir mat - Vérins de réglage.
Cast iron - Powder coated in black - Adjustable footplugs.



S14

Prato 16

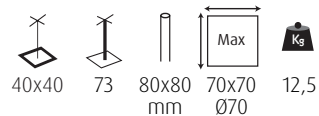

Prato 19

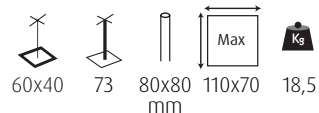

Prato 30

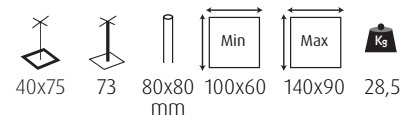

Prato

Pied de table - *Table base*



Prato 16 Bar



Prato 30 Bar

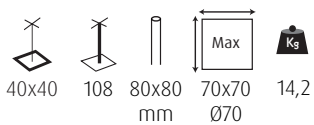

Prato 16 Bar

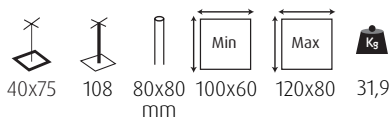

Prato 30 Bar

Noir
Black



Fonte d'acier - Epoxy noir mat - Vérins de réglage.
Cast iron - Powder coated in black - Adjustable footplugs.



S14

Prato

Pied de table - Table base



Prato 15



Prato 15 Bar

Noir
Black

Fonte d'acier - Epoxy noir mat - Vérins de réglage.
Cast iron - Powder coated in black - Adjustable footplugs.



S14

Prato 15

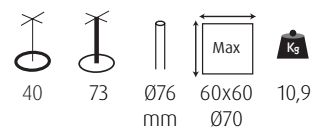

Prato 15 Bar

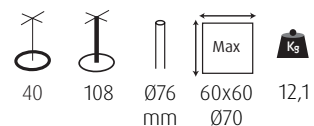

Prato

Pied de table - Table base



Prato 20



Prato 70

Noir
Black

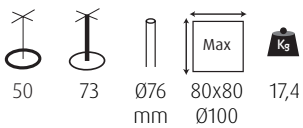

Prato 20

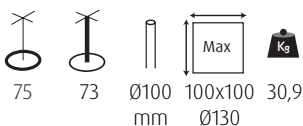

Prato 70

Fonte d'acier - Epoxy noir mat - Vérins de réglage.
Cast iron - Powder coated in black - Adjustable footplugs.



S14

Rome

Pied de table - Table base



Rome 05



Rome 06



Rome 05 Bar

Noir
Black



Fonte d'acier - Epoxy noir - Vérins de réglage.
Cast iron - Powder coated in black - Adjustable footplugs.



S15

Rome 05					
	43	73	Ø76 mm	60x60 Ø80	14
Rome 06					
	55	73	Ø76 mm	90x90 Ø120	21
Rome 05 Bar					
	43	108	Ø76 mm	60x60 Ø70	15

Rome

Pied de table - Table base

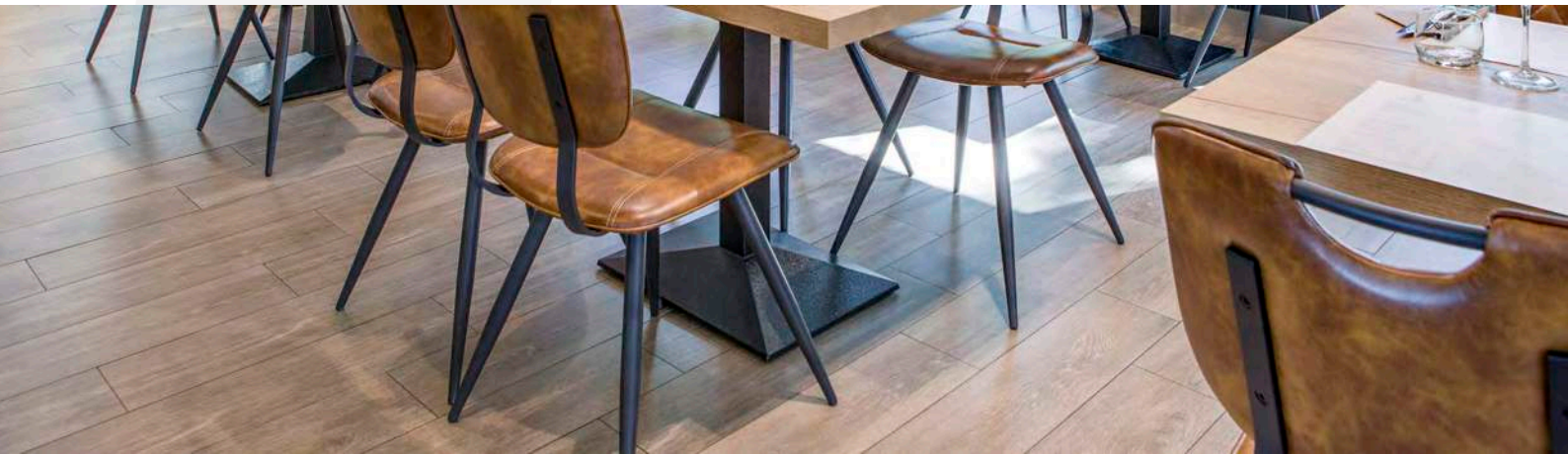

Rome 12



Rome 13



Rome 12 Bar

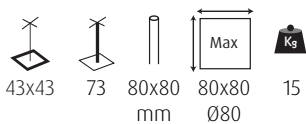

Rome 12

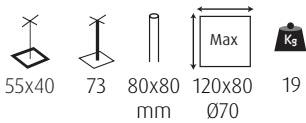

Rome 13

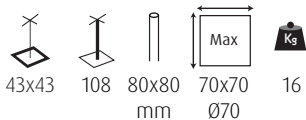

Rome 12 Bar

Noir
Black



Fonte d'acier - Epoxy noir - Vérins de réglage.
Cast iron - Powder coated in black - Adjustable footplugs.



S15

Sydney

Pied de table - Table base

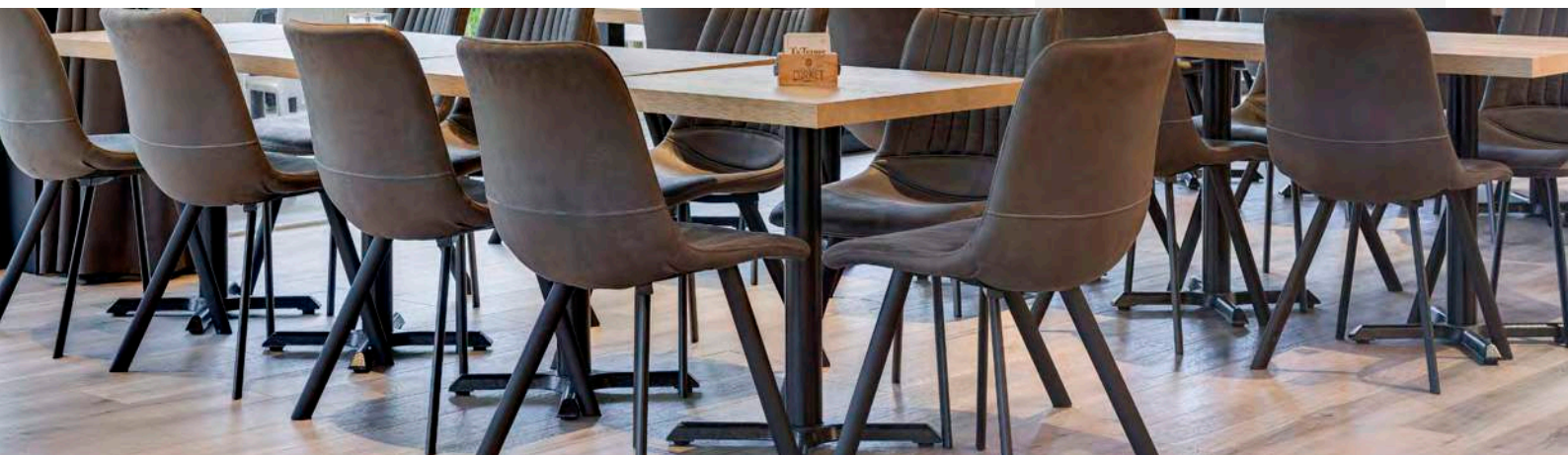

Sydney 4



Sydney Double



Noir
Black

Fonte d'acier - Epoxy noir - Vérins de réglage.
Cast iron - Powder coated in black - Adjustable footplugs



S15

Sydney 4

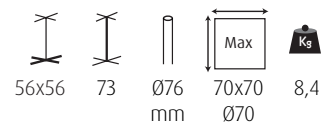

Sydney Double

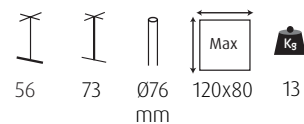

Sydney

Pied de table - *Table base*



Sydney 4 Bar

Noir
Black

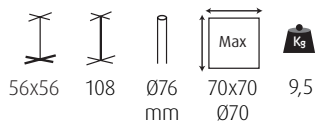

Sydney 4 Bar

Fonte d'acier - Epoxy noir - Vérins de réglage.
Cast iron - Powder coated in black - Adjustable footplugs.



S15

Stratifié - Laminate



New

Perfect Sense Collection

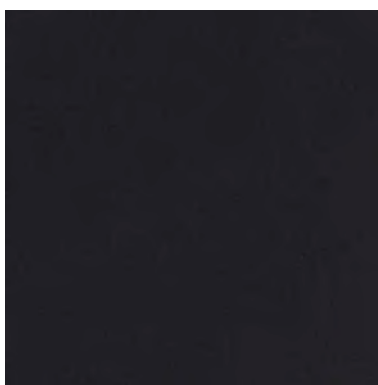
Plateau de table - *Table top*



Noir - *Black*
PT U999

		
cm	60x60 70x70	120x70
20mm	4,8kg 6,5kg	11,2kg

 p295

Plateau stratifié - Chants en ABS - Extra mat - Toucher soyeux - Anti-traces de doigts - Anti-reflets - Disponible en épaisseur 20mm uniquement*.

Laminate table top - ABS edges - Extra matte - Silky touch - Anti-fingerprint - Anti-reflective - Available only in thickness of 20mm.*



ANTI
FINGERPRINT



MATTE -
LOW REFLECTIVITY





Stratifié-Laminate

Perfect Sense Collection

Stratifié - Laminate

New

Original Collection

Plateau de table - Table top



Marbre Blanc
OF253 BST

New



Béton Concrete
F 275

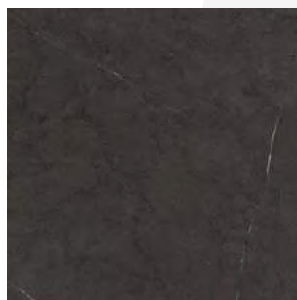

Marmara
F 160 ST9

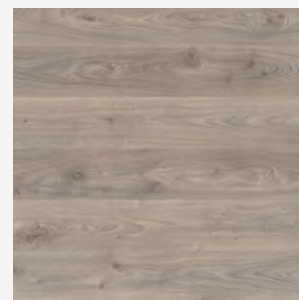

Minnesota Oak Greige
H 160

cm	□			▭				○	
	60x60	70x70	80x80	60x70	110x70	120x70	120x80	Ø70	Ø120 *
24mm	6,8kg	8,1kg	10,9kg	7,5kg	12,9kg	14kg	16,2kg	6,4kg	21,3kg

* 26 mm

 p295

Plateau stratifié - Chants en ABS - Disponible en épaisseur 24mm uniquement*.
Laminate table top - ABS edges - Available only in thickness of 24mm*.





Stratifié-Laminate

Original Collection

Stratifié - Laminate

Chêne - Oak Halifax

Plateau de table - Table top



Chêne Halifax Naturel
H 1180 ST37



Chêne Halifax Tabac
H1181 ST37

	□			▭				○	
cm	60x60	70x70	80x80	60x70	110x70	120x70	120x80	Ø70	Ø120 *
24mm	5,9kg	8,3kg	10,4kg	7,2kg	12,7kg	13,7kg	16,1kg	6,5kg	19,7kg 26 mm
46mm	8,5kg	10,7kg	13,5kg	9,4kg	15,7kg	17,1kg	19,2kg	/	/

* Uniquement: Naturel H 1180 ST37

* Only: Naturel H 1180 ST37

 p295

Plateau stratifié aspect bois - Chants en ABS imitation « Bois de bout » - Toucher « Feelwood » : suit les fibres du bois.

Laminate table top with wood-like appearance - ABS edges - « Feelwood » touch : realistic look and feel of the wooden fibers..





Stratifié-Laminate

Chêne - Oak Halifax

Mé laminé

Melamine



Plateau de table - Table top



Minnesota Oak Chocolat
H441 Z5L



Chêne Halifax Naturel
H 1180 ST37

			
cm	60x60	70x70	120x70
18mm	4,4kg	6,2kg	11,2kg

 p295

Plateau mélaminé aspect bois - Chants en ABS imitation « Bois de bout »
Toucher « Feelwood » : suit les fibres du bois - Epaisseur 18mm.

*Melamine table top with wood-like appearance - ABS edges - « Feelwood »
touch : realistic look and feel of the wooden fibers - Thickness 18mm.*

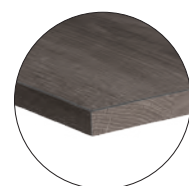



Mélaminé

Melamine



Odense

Chêne-Oak

Plateau de table - Table top



Finition rustique naturelle brossée
Natural rustic brushed finish

		
cm	60x60	70x70
30mm	8,4kg	11,1kg

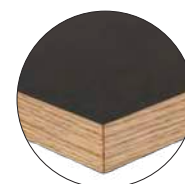

Dessous
Underside

 p295

Plateau bois plaqué chêne - Finition rustique naturelle brossée - 4 couches de vernis polyuréthane satiné - Epaisseur 30mm.

Wooden oak veneered top - Natural rustic brushed finish - 4 coats of polyurethane satin lacquer - Thickness 30mm.

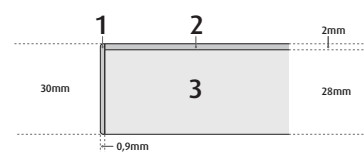

- | | |
|-------------------|-----------------|
| 1. Chants plaqués | 1. Veneer edges |
| 2. Plaquage Chêne | 2. Oak veneer |
| 3. Aggloméré | 3. Chipboard |



Odense

Chêne-Oak

William

Buffet - Buffet



Wengé Louisiana
Wenge Louisiana

Grey Bardolino Oak
Grey Bardolino Oak

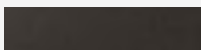

Structure en mélamine - Tablettes en stratifié - 4 roulettes dont 2 avec frein - Porte à droite - Meuble monté - Usage intérieur uniquement.
Melamine structure - Laminated shelves - 4 casters, including 2 with brakes - Door on the right side - Assembled - Indoor use only.

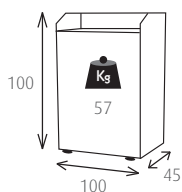



William

Jacky

Meuble poubelle - Waste bin



OPTION

Poubelle PVC 80L
PVC trashbin 80L



80 L



Wengé Louisiana
Wenge Louisiana

Grey Bardolino Oak
Grey Bardolino Oak



Structure en mélamine - Tablette en stratifié - Battant en inox lesté - 4 roulettes dont 2 avec frein - Fermeture à clé - Meuble monté - Usage intérieur uniquement.

Melamine structure - Laminated shelf - Weighted stainless steel flap - 4 casters, including 2 with brakes - Key lock - Assembled - Indoor use only.

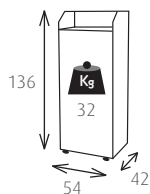



Jacky





Réception - Catering

Daisy

Chaise - Chair

Stock
Limité
Limited
Stock



Argent & Noir
Silver & Black

Stock
Limité
Limited
Stock



Structure en acier 20x20x1mm - Assise en mousse moulée - Assise et dos garnis de similicuir.
Steel frame 20x20x1mm - Molded foam seat - Seat and back upholstered with faux-leather.





Daisy

Tiffany

Stock
Limité
Limited
Stock

Chaise - Chair



Noir Brillant
Glossy Black

Stock
Limité
Limited
Stock

Monobloc polypropylène.
Polypropylene monobloc.





Tiffany

Napoléon

Stock
Limité
Limited
Stock

Chaise - Chair



Blanc
White

Stock
Limité
Limited
Stock



Monobloc polypropylène.
Polypropylene monobloc.





Napoléon

XL 180

Table - Table

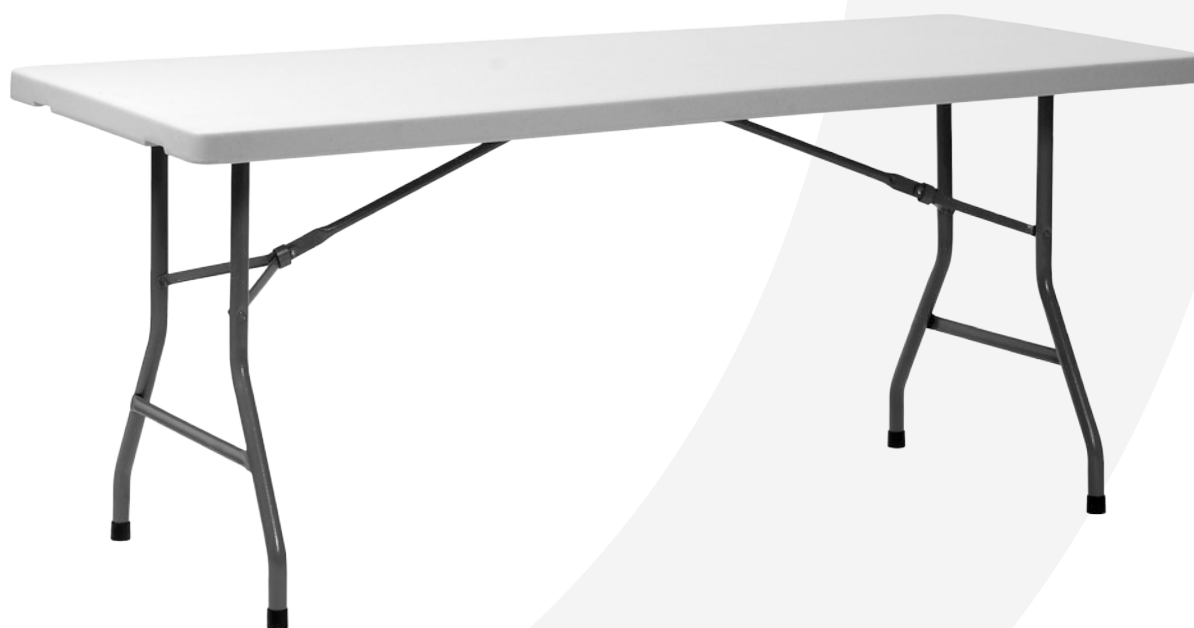

Blanc
White



Piètement métallique pliant - Diamètre tube 28mm - Plateau polyéthylène épaisseur 45mm.
Folding metal table base - Tube diameter 28mm - Polyethylene table top thickness 45mm.



182x75 74 14



Cocktail 80

Table haute - *High table*

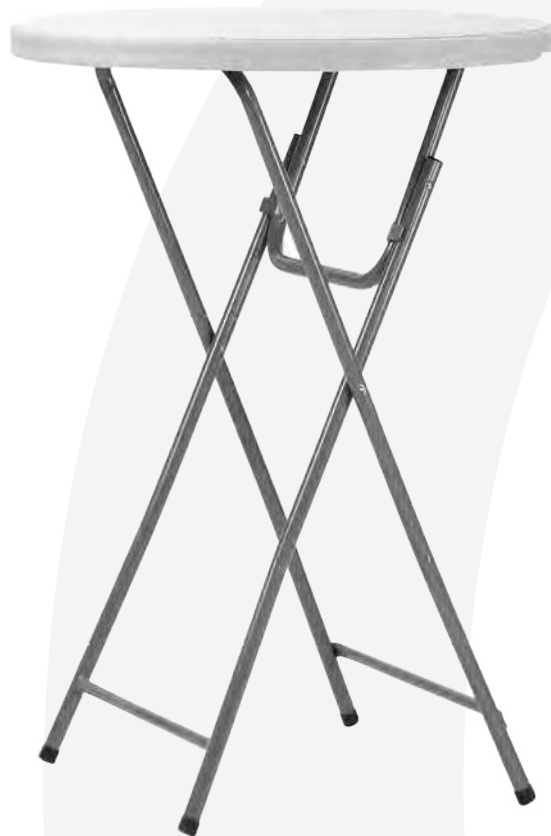

Blanc
White



Piètement métallique pliant - Diamètre tube 22mm - Plateau polyéthylène épaisseur 45mm.
Folding metal table base - Tube diameter 22mm - Polyethylene table top thickness 45mm.



81 110 8

Osaka

Nappe - Cover



Noir
Black



Comprend : 1 nappe + 1 surnappe - Finition stretch 100% polyester - Renforts sur les pieds.
Consists of 1 table cover + 1 topper - 100% stretch polyester - Foot reinforcements.



Pack Cocktail 80 & Osaka

Ensemble - Set

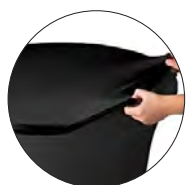

Noir
Black



Ensemble composé de : **1** table Cocktail 80 + **1** nappe + **1** surnappe Osaka - Noir.
Set composed of : **1** Cocktail 80 table + **1** Osaka cover + **1** topper - Black.







Divers - Miscellaneous Info

Informations techniques

Technical information

Textilène - *Textilene*

Fibre de polyester enduite de PVC.
Coated polyester fiber.



→ Disponible dans la boîte échantillons
Available in the sample box

Revêtement textilène - *Textilene covering*



Seine
Camel & Blanc
Camel & White 8x8

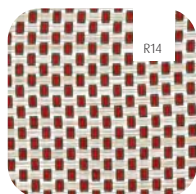

Paris
Bordeaux & Crème
Bordeaux & Cream 8x8

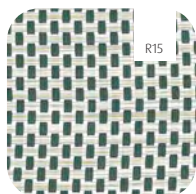

Paris
Vert & Crème
Green & Cream 8x8

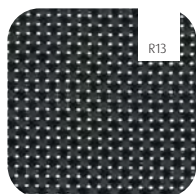

Paris/Montmartre
Noir
Black 8x8

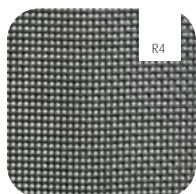

Dauphine
Noir
Black 2x2



Drouot/Trocadero
Noir & Gris Clair
Black & Light Grey 8x8

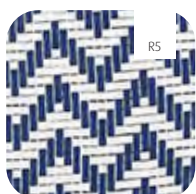

Louvre
Blanc & Bleu Océan
White & Ocean Blue 8x8

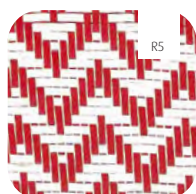

Louvre
Blanc & Pimento
White & Pimento 8x8



Reims/Blois/Dole
Gris & Beige
Grey & Beige 4x4

Corde textilène - *Textilene rope*



Concorde
Anthracite
Anthracite



Murcia
Terracotta
Terracotta



Murcia
Noir
Black



Murcia
Taupe
Taupe

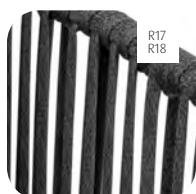

Cadix
Anthracite
Anthracite

Tressage PE - *PE Wicker*



→ Disponible dans la boîte échantillons
Available in the sample box



Amsterdam/Breda
Olive
Olive 5mm



Amsterdam/Breda
Paille
Straw 5mm



Amsterdam/Breda
Anthracite
Anthracite 5mm

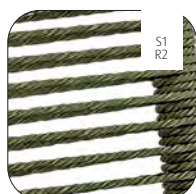

Savana
Olive
Olive 5mm



Savana
Paille
Straw 5mm

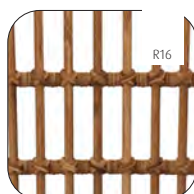

Orléans
Rotin Noisette
Nut Rattan

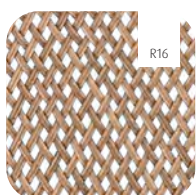

Rochelle/Dax
Rotin Noisette
Nut Rattan



Brest/Laval
Rotin Noisette
Nut Rattan



Saint-Tropez
Noir
Black 3,8mm



Saint-Tropez
Gris Pierre
Stone Grey 3,8mm



Vilette/Passy
Madeleine
Gris & Blanc
Grey & White



Vilette/Passy
Madeleine
Noir
Black

Informations techniques

Technical information

Polypropylène - Polypropylene



→ Disponible dans la boîte échantillons
Available in the sample box



Monna/Maya/Ulysse/Atlantic/
Penelope/Tom Bar/Sky Pro/
Marcel/Marcel XL/Marcel Bst
Noir Mat
Matte Black



Monna/Maya/Tom Bar/
Sky Pro
Olive
Olive



Monna
Moutarde
Moutarde



Monna
Octane
Octane



Ulysse/Penelope/
Tom Bar
Marsala
Marsala



Maya/Sky
Blanc
White



Maya
Anthracite
Anthracite



Fado
Anthracite
Anthracite



Daytona/Panama/Jamaica
Jamaica F/Jamaica Bst
Gris Foncé
Dark Grey



Dubai/Jeddah/Oman
Anthracite
Anthracite

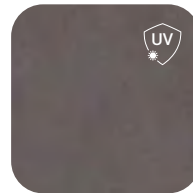

Dubai/Jeddah/Oman
Taupe
Taupe



Dubai/Jeddah/Oman
Sauge
Sage



Dubai/Jeddah/Oman
Terra
Terra

Dubai/Jeddah/Oman :



CEN/TR 581-4:2005 ;
ISO 4892-2:2013/Amd. 1:2021 Cycle 1 ;
ISO 4628-2:2016 ; ISO 4628-4:2016 ;
ISO 4628-5:2016 ; ISO 4628-6:2011

Résistance aux UV
UV Resistant

Métal - Metal



→ Disponible dans la boîte échantillons
Available in the sample box



Bastille/Bastille Bst/
Pigalle
Olive
Olive

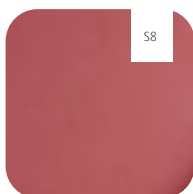

Bastille/Bastille Bst/
Pigalle
Pimento
Pimento



Bastille/Bastille Bst/
Pigalle
Anthracite
Anthracite

Bastille/Bastille Bst :



ISO 4892-3:2016

Résistance aux UV
UV Resistant



Échantillons - Samples

N'hésitez pas à commander votre boîte d'échantillons à info@flexmob.com
Don't hesitate to order your sample box at info@flexmob.com

Informations techniques

Technical information

Compact Easy - *Compact Easy*

Chants droits - Système de fixation universel.
Straight edges - Universal fixing system.



→ Disponible dans la boîte échantillons
Available in the sample box



Colorado
459



Corten
406



Grafito
918

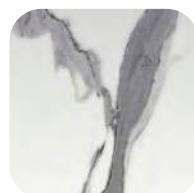

Marmo Bianco
654

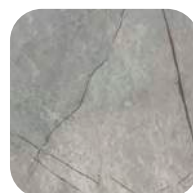

Marmo Griggio
671



Slate
658



California Oak
679



Black Marble
1541



Dark Metal
919



Stone Grey
637

Werzalit Classique - *Werzalit Classic*

Plateau stratifié moulé.
Molded laminated top.



→ Disponible dans la boîte échantillons
Available in the sample box



Avalon Pine
4729

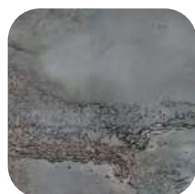

Irony
9687



Malaga
5766



Grey Marble
5666

Topalit - *Topalit*

Plateau stratifié moulé.
Molded laminated top.



Atacama Cherry
0222



Veneto
0249

Werzalit Cerclés - *Werzalit Rimmed*

Plateau stratifié moulé
 Cerclage métallique finition laiton.
Rimmed table top - Brass finish.



→ Disponible dans la boîte échantillons
Available in the sample box



Marrakesh
5717



Mermer
5410



Black Siyah
3190

Informations techniques

Technical information

Tables Basses - Low Tables

Plateau mélaminé.
Melamine table top.



Maryne
Marbre noir
Black marble



Jolyne
Mango
Mango



Jolyne
Noir
Black



Ellen
Naturel
Natural

Stratifié Perfect Sense Collection - Laminate Perfect Sense Collection

Plateau stratifié - Chants en ABS - Extra mat - Toucher soyeux
- Anti-traces de doigts - Anti-reflets.

Laminate table top - ABS edges - Extra matte - Silky touch -
Anti-fingerprint - Anti-reflective.



ANTI
FINGERPRINT



MATTE -
LOW REFLECTIVITY



Noir - Black
PT U999

Stratifié Original Collection - Laminat Original collection

Plateau stratifié - Chants en ABS (Acrylonitrile Butadiène Styrene).
Molded laminated top - ABS (Acrylonitrile Butadiene Styrene) edges.



Marbre Blanc
OF253 BST



Béton Concrete
F275



Marmara
F 160 ST9



Minnesota Oak Greige
H 160

Stratifié Chêne - Laminat Oak Halifax

Plateau stratifié aspect bois toucher «feelwood» - Chants en ABS (Acrylonitrile Butadiène Styrene) imitation bois de bout.
«Feelwood» wood-look laminated top - ABS (Acrylonitrile Butadiene Styrene) edges.

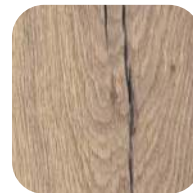

Chêne Halifax
Naturel H1180 ST37



Chêne Halifax
Tabac H1181 ST37

Mélaminé - Melamine

Plateau mélaminé aspect bois toucher «feelwood» - Chants en ABS (Acrylonitrile Butadiène Styrene) imitation bois de bout.
«Feelwood» wood-look melamine top - ABS (Acrylonitrile Butadiene Styrene) edges.



Chêne Halifax
Naturel H1180 ST37



Minnesota Oak
Chocolat H441 Z5L

Odense

Bois plaqué chêne - 4 couches de vernis polyuréthane satiné.
Oak veneered wood - 4 coats of polyurethane satin lacquer.



Finition rustique naturelle brossée
Natural rustic brushed finish

→ 
Disponible dans la boîte échantillons
Available in the sample box

Informations techniques

Technical information

Revêtements - Upholstery

Entretien

Le nettoyage et l'entretien réguliers des tissus d'ameublement prolongent leur durée de vie et empêchent la formation de salissures permanentes. Une solution d'eau et de savon doux peut être utilisée pour nettoyer le tissu.

Conservation

Le boulochage des tissus est un processus naturel et peut ne pas être complètement éliminé. L'exposition à la lumière UV et aux sources de chaleur peut provoquer une décoloration du tissu (ceci concerne principalement les couleurs intenses). Pour des raisons technologiques, la teinte d'un tissu peut différer d'un ton par rapport à l'échantillon présenté dans le catalogue. Les photos sont non contractuelles. Les tissus sont conformes aux exigences du règlement européen sur les produits chimiques dangereux (REACH) n° 1907/2006, annexe XVII.

Nettoyage

Étape 1: Enlevez soigneusement l'excès de saleté.

Étape 2: Imbibez la tache d'eau froide et épongez-la avec une serviette en papier.

Étape 3: Laissez sécher.

Maintenance

Regular cleaning and maintenance of upholstery fabrics prolongs their life and prevents the formation of permanent soiling. A mild soap and water solution can be used to clean the fabric.

Preservation

Pilling of fabrics is a natural process and may not be completely eliminated. Exposure to UV light and heat sources can cause discoloration of the fabric (this applies mainly to dark colours). For technological reasons, the shade of a fabric may differ by one shade from the sample shown in the catalog. Photos are non-contractual. Fabrics comply with the requirements of the European regulation on hazardous chemicals (REACH) n° 1907/2006, annex XVII.

Cleaning

Step 1: Carefully remove excess dirt.

Step 2: Soak the stain in cold water and blot with a paper towel.

Step 3: Allow to dry.



Une question sur l'entretien de nos produits? Any questions about the care of our products?

Notre équipe commerciale est à votre disposition pour vous conseiller: info@flexmob.com
Our sales team is at your disposal: info@flexmob.com

Aragon • Simone, René, Auguste



Vert 39
Green 39



Terra 59
Terra 59



Gris Clair 83
Light Grey 83

Composition

5% NY
95% PES

Poids - Weight

340 g/m² (+/-5%)

Test Martindale

45.000-60.000 tours min.

Largeur rouleau

Usable width of rol

140 cm.



BS 5852/0
EN 1021/1



WATER
REPELLENT



DAVIS
FABRICS

www.davis.pl/kolekcja/aragon

Gava • Mélina, Sandra



Gris 18
Grey 18

Composition

100% Recycled PES

Poids - Weight

450 g/m²

Test Martindale

90.000/100.000 tours min

Largeur rouleau

Usable width of rol

140 cm.



BS 5852/0
EN 1021/1



WATER
REPELLENT



RECYCLED
POLYESTER



DAVIS
FABRICS

www.davis.pl/kolekcja/gava

Luis • Kate



Vert 34
Green 34

Bleu 75
Blue 75



Gris 90
Grey 90

Rouille 52
Rusty 52

Composition
100% PES

Poids - *Weight*
350 g/m²

Test Martindale
20.000-30.000 tours min.

Largeur rouleau - *Usable width of rol*
140 cm.

www.davis.pl/kolekcja/luis



EN 1021/1



WATER REPELLENT



DAVIS
FABRICS

Monolith • Maurice, Maurice Bst, Emile, Alfonse, Oscar Bst, Lautrec S, Arnold, Willy



Anthracite 92

Burgundy 69

Gold 48



Petrol 76

Olive 38

Composition
100% PES

Poids - *Weight*
330g/m² (+/-5%)

Test Martindale
90.000/100.000 tours min.

Largeur rouleau
Usable width of rol
140 cm.

www.davis.pl/kolekcja/monolith



EN 1021/1



WATER REPELLENT



DAVIS
FABRICS

Grace • Paulette, Colette, Adèle, Victoire Bst



Corde 16
Rope 16

Tempête 77
Tempest 77

Composition
70% Recycled PES
30% PES

Poids - *Weight*
600g/m² (+/-5%)

Test Martindale
60.000/70.000 tours min.

Largeur rouleau
Usable width of rol
140 cm.

www.davis.pl/kolekcja/grace



EN 1021/1



EASY CLEAN



RECYCLED POLYESTER



DAVIS
FABRICS

Cloud • Paulette, Colette, Adèle, Victoire Bst



Pierre 87
Stone 87

Orage 97
Storm 97

Composition
100% PES

Poids - *Weight*
390 g/m² (+/-10%)

Test Martindale
90.000/100.000 tours min.

Largeur rouleau
Usable width of rol
140 cm.

www.davis.pl/kolekcja/cloud



EN 1021/1



EASY CLEAN



DAVIS
FABRICS

Informations techniques

Technical information

Revêtements - Upholstery

Miss • Zoé, Ralph



Beige 032
Beige 032



Gris/Brun 056
Brown/Grey 056



Olive 144
Olive 144



Orange 106
Orange 106

Composition
96% PES 4%NY

Poids - Weight
410g/m²

Test Martindale
40.000 tours min.

Largeur rouleau
Usable width of rol
142 cm.



Colorado • Mikka, Olaf, Jacob, Kyle, Wendy



Cuio



Anthracite

Composition
100% PU
81% PES + 15% Cotton
+ 4% Viscose

Poids - Weight
630g/m² (+/-5%)

Test Martindale
>100.000 tours min.

Largeur rouleau
Usable width of rol
140 cm.



BS 5852/0
EN 1021/1



www.elastrongroup.com/en/upholstery/fabrics/colorado

Brego • Noëlia



Gris 10
Grey 10

Composition
100% PES

Poids - Weight
380g/m²

Test Martindale
30.000 tours min

Largeur rouleau
Usable width of rol
140 cm.



www.fabb.pl/brego-collection

Cortes • Cuba, Cuba Double



Composition
100% PES

Poids - Weight
330g/m²

Test Martindale
35.000 tours min.



www.fabb.pl/cortes-collection

Luxor • Pickup



Composition
100% PES

Poids - Weight
310g/m²

Test Martindale
25.000 tours min.

Lotos • Budapest, Budapest Bst, Dimitri, Dimitri Bst, Brooklyn, Brooklyn Bst, Pub, Pub Bst, Clinton, Clinton Bst



Olive 9430



Terra 9244



Noir 7006
Black 7006



Éléphant 5272
Elephant 5272



Cappuccino 5582



Bordeaux 5269

Composition
100% PU

Poids - Weight
392g/m² (+/-5%)

Test Martindale
>100.000 tours min.

Largeur rouleau
Usable width of rol
140 cm.

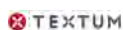

www.textum-stoffe.com/products-detail.html?fabric_name=Lotos

Softyl • Condor



Composition
100% PES

Poids - Weight
360g/m²

Test Martindale
45.000 tours min.

PU • Floriane II, Floriane Bst II



Chocolat 928
Chocolate 928

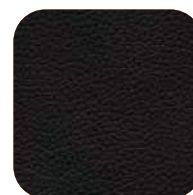

Noir 9100
Black 9100



Taupe 926
Taupe 926

Composition
66% PU
30% PES
1,3% CV
2,7% COT

Poids - Weight
340g/m² (+/-5%)

Test Martindale
100.000 tours min.

Largeur rouleau
Usable width of rol
144 cm.



Victory • Barossa



Cognac

Composition
100% PU

Poids - Weight
440g/m²

Test Martindale
50.000 tours min

Informations techniques

Technical information

Non-feu

PVC Classement Non-feu - Normes EN 1021 partie 1 (EN 1021/1) ou EN 1021 partie 2 (EN 1021/2)
PVC fire resistant rating - Standards EN 1021 part 1 (EN 1021/1) or EN 1021 part 2 (EN 1021/2)



Méthode de test:

Un banc d'essai est construit à l'aide de mousse et de tissu pour simuler une chaise.

1. Méthode de test - Partie 1: Une cigarette est allumée et placée dans la crevasse du banc de test en contact avec le dossier et le siège. Elle se consume sur toute sa longueur. Le tissu est observé par rapport à la couvaison ou l'inflammation.

2. Méthode de test - Partie 2: Le banc de test composé est à présent testé avec une flamme au butane, qui simule une allumette allumée, dans la crevasse. Après avoir retiré la flamme, le tissu est observé pour voir s'il couve ou s'enflamme dans les 2 min.

3. Résultat: Le matériau de test réussit le test s'il n'y a pas eu d'inflammation ou en cas de zone de combustion limitée.

Test method:

A test rig is constructed using foam and fabric in order to simulate a chair.

1. Test method - Part 1: A cigarette is lit and placed in the crevice of the test rig which is in contact with the backrest and the seat. The cigarette is left to smoulder while the reaction of the tissue is being observed during the process of combustion and inflammation.

2. Test method - Part 2: The test rig is now tested with a butane flame, which simulates a burning match, placed into the crevice. After removing the flame, the reaction of the tissue is being observed to see if it smoulders or ignites within 2 minutes.

3. Result: The test material passes the test if there is no evidence of ignition or if the smouldering site is within the limited acceptable size.

PVC Classement Non-feu - Norme BS 5852 source 0
PVC fire resistant rating - Standard BS 5852 source 0

Méthode de test:

Un banc d'essai est construit pour simuler une chaise avec le tissu à tester. Ce banc est soumis à différentes sources d'allumage. Il y a 8 types de sources d'allumage, chacune avec une intensité de chaleur différente. Elles sont classées de 1 à 8, avec une intensité qui double par rapport à la source précédente.

1. Méthode de test - Source 0: Cigarette qui se consume. Une cigarette est placée le long de la crevasse du banc de test et peut brûler sur toute sa longueur.

Si aucune inflammation ou couvaison progressive n'est observée sur la couverture et le matériau intérieur, le test est enregistré comme étant sans allumage et le matériau réussit le test.

2. Résultat: Le matériau de test réussit le test s'il n'y a pas eu d'inflammation ou en cas de zone de combustion limitée.

Test method:

A test rig is constructed in order to simulate a chair with the fabric to be tested. This rig is subjected to different ignition sources. There are 8 types of ignition sources, each with different heat intensity. They are classified from 1 to 8, the intensity doubling the precedent source.

1. Test method Source 0: A smouldering cigarette. It is lit and placed in the crevice of the test rig and is left to smoulder. If no combustion or inflammation is observed on the cover and the inner material, the test is recorded as no ignition and the material passes the test.

2. Result: The test material passes the test if there is no evidence of ignition or if smouldering site is within the limited acceptable size.

Informations techniques

Technical information

Stratifié/Méla miné - HPL/Melamine



Méla miné
Melamine



Stratifié
HPL

Comparatif Comparison

Résistance à la chaleur:

Le stratifié est plus résistant à la chaleur et sera donc conseillé dans le cas d'une utilisation avec service de plats chauds à table.

Réaction au feu:

Méla miné: M3 Stratifié: M2

Résistance à l'usure:

Le stratifié comprend une couche de protection, pas le méla miné.

Résistance aux coups/chocs:

Le stratifié comprend une couche support en résine, pas le méla miné ; le méla miné est appliqué directement sur le panneau aggloméré.

Prix:

Le stratifié est sensiblement plus cher que le méla miné.

Heat resistance:

HPL is more resistant to heat and is therefore advised for use with hot plates.

Reaction to fire:

Melamine: M3 HPL: M2

Wear resistance:

HPL has a protective coating and melamine does not.

Stock/Impact resistance:

HPL has an additional layer of resin while the melamine is directly applied to the chipboard.

Price:

HPL is significantly more expensive than melamine.

Composition Composition

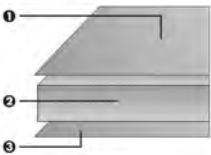

Méla miné
Melamine

Un film de méla miné est appliqué sur le panneau aggloméré à pression et température élevées. Ce film comprend un papier de base trempé dans de la résine de méla miné. Il peut être imprimé ou non et son poids peut varier. Un papier plus lourd peut absorber plus de résine, de sorte que la couche de méla miné est aussi plus épaisse.

1. Feuille de papier décoratif, imprégnée de résine de méla miné.
2. Panneau aggloméré.
3. Feuille de papier décoratif, imprégnée de résine de méla miné.

A melamine film is pressed onto the chipboard at high pressure and temperature. This film consists of a paper substrate saturated with melamine resin. This paper may or may not be printed and its weight may vary. A heavier paper can absorb more resin, resulting in a thicker melamine layer.

1. Sheet of decorative paper saturated with melamine resin.
2. Chipboard.
3. Sheet of decorative paper saturated with melamine resin.

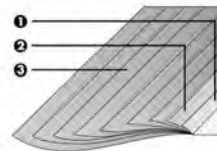

Stratifié
HPL

Le stratifié à haute pression est constitué d'un empilement de feuilles de papier imprégnées de résines thermodurcissables, qui sont polymérisées sous l'effet d'une pression (8 MPa) et d'une température élevée (150°C).

1. Couche de protection (overlay) imprégnée de résine méla miné (pour tous les décors).
2. Papier décoratif : teinté dans la masse pour les teintes unies ou imprimé pour les décors, imprégné de résine de méla miné.
3. Coeur: un certain nombre de feuilles de papier kraft, imprégnées de résine de phénol.

High-pressure laminate consists of a stack of sheets of paper saturated with thermosetting resin which are polymerized under high pressure (8 MPa) and temperature (150°C).

1. Melamine resin-saturated overlay (for all decors).
2. Decorative paper: mass-dyed for solid colors or printed for decors, saturated with melamine resin.
3. Core: a number of sheets of kraft paper, saturated with phenol resin.

Correspondance Pieds/Plateaux

Matching table tops and bases

Piètements Extérieurs Outdoor Table Bases		Verona 3	Verona 4	Verona Double	Verona 4 Bar	Monza	Monza Bar	Berlin 4	Berlin 2	Berlin 4 Bar	
Compact Easy	65x65	-	✓☁	-	✓☁	✓☁	-	✓☁	-	✓☁	
Werzalit Classic	60x60	-	✓☁	-	✓☁	✓☁	✓☁	✓☁	-	✓☁	
	70x70	-	✓☁	-	✓☁	✓☁	-	✓☁	-	✓☁	
	Ø60	✓☁	-	-	-	-	✓☁	-	-	-	
Topalit Classic	60x60	-	✓☁	-	✓☁	✓☁	✓☁	✓☁	-	✓☁	
	70x70	-	✓☁	-	✓☁	✓☁	-	✓☁	-	✓☁	
Werzalit Cerclés Werzalit Rimmed	Ø60	✓☁	-	-	-	-	✓☁	-	-	-	
Stratifié Perfect Sense Collection Perfect Sense Laminate	60x60	-	✓	-	✓	✓	✓	✓	-	✓	
	70x70	-	✓	-	✓	✓	-	✓	-	✓	
	20mm Noir - Black	120x70	-	-	✓	-	-	-	✓	-	
Stratifié Original Collection Original Collection Laminate	60x60	-	✓	-	✓	✓	✓	✓	-	✓	
	70x70	-	✓	-	✓	✓	-	✓	-	✓	
	24mm	80x80	-	-	-	-	-	✓	-	-	
	Marbre Blanc - White Marble Béton Concrete Marmara Minnesota Oak Greige	60x70	-	✓	-	✓	✓	-	✓	-	✓
		110x70	-	-	✓	-	-	-	-	✓	-
		120x70	-	-	✓	-	-	-	-	✓	-
	Stratifié Chêne Halifax Oak Halifax Laminate	120x80	-	-	✓	-	-	-	-	✓	-
24mm & 46mm		Ø70	-	✓	-	✓	✓	✓	-	✓	
		Ø120	-	-	-	-	-	-	-	-	-
Mélaminé Melamine	60x60	-	✓	-	✓	✓	✓	✓	-	✓	
	18mm	70x70	-	✓	-	✓	✓	✓	-	✓	
	Minnesota Oak Chocolat Chêne Halifax Naturel	120x70	-	-	✓	-	-	-	-	✓	-
Chêne Odense Oak Odense		60x60	-	✓	-	✓	✓	✓	-	✓	
	70x70	-	✓	-	✓	✓	-	✓	-	✓	
	30mm	120x70	-	-	✓	-	-	-	✓	-	

Correspondance Pieds/Plateaux

Matching table tops and bases

Piètements Extérieurs Outdoor Table Bases		Empire 3	Empire 4	Empire 4 Bar	Empire 2	Empire Grande	Bistrot 3 H43	Bistrot 3	Bistrot 4	Bistrot 3 Bar
Compact Easy	65x65	-	✓☁	-	-	-	-	-	✓☁	-
Werzalit Classic Avalon Pine Irony Malaga Grey Marble	60x60	✓☁	✓☁	✓☁	-	-	✓☁	✓☁	✓☁	✓☁
	70x70	-	✓☁	-	-	-	-	-	✓☁	-
	Ø60	✓☁	✓☁	✓☁	-	-	✓☁	✓☁	✓☁	✓☁
Topalit Classic Venetto Atacama Cherry	60x60	✓☁	✓☁	✓☁	-	-	✓☁	✓☁	✓☁	✓☁
	70x70	-	✓☁	-	-	-	-	-	✓☁	-
Werzalit Cerclés Werzalit Rimmed Marrakesh Mermer Black Siyah	Ø60	✓☁	✓☁	✓☁	-	-	✓☁	✓☁	✓☁	✓☁
Stratifié Perfect Sense Collection Perfect Sense Laminate 20mm Noir - Black	60x60	✓	✓	✓	-	-	✓	✓	✓	✓
	70x70	-	✓	-	-	-	-	-	✓	-
	120x70	-	-	-	✓	-	-	-	-	-
Stratifié Original Collection Original Collection Laminate 24mm Marbre Blanc - White Marble Béton Concrete Marmara Minnesota Oak Greige Stratifié Chêne Halifax Oak Halifax Laminate 24mm & 46mm Chêne Halifax Naturel Chêne Halifax Tabac	60x60	✓	✓	✓	-	-	✓	✓	✓	✓
	70x70	-	✓	-	-	-	-	-	✓	-
	80x80	-	-	-	-	✓	-	-	-	-
	60x70	-	✓	-	-	-	-	-	✓	-
	110x70	-	-	-	✓	-	-	-	-	-
	120x70	-	-	-	✓	-	-	-	-	-
	120x80	-	-	-	✓	-	-	-	-	-
	Ø70	✓	✓	✓	-	-	-	-	✓	✓
Ø120	-	-	-	-	✓	-	-	-	-	
Mélaminé Melamine 18mm Minnesota Oak Chocolat Chêne Halifax Naturel	60x60	✓	✓	✓	-	-	✓	✓	✓	✓
	70x70	-	✓	-	-	-	-	-	✓	-
	120x70	-	-	-	✓	-	-	-	-	-
Chêne Odense Oak Odense 30mm	60x60	✓	✓	✓	-	-	✓	✓	✓	✓
	70x70	-	✓	-	-	-	-	-	✓	-
	120x70	-	-	-	✓	-	-	-	-	-

Correspondance Pieds/Plateaux

Matching table tops and bases

Piètements Intérieurs Indoor Tables Bases		Factory 70	Retro Small	Retro Large	Prato 16	Prato 19	Prato 30	Prato 16 Bar	Prato 30 Bar	Prato 15	Prato 20	Prato 15 Bar	Prato 70
Compact Easy	65x65	-	-	-	✓	-	-	✓	-	-	✓	-	-
Werzalit Classic Avalon Pine Irony Malaga Grey Marble	60x60	-	-	-	✓	-	-	✓	-	✓	✓	✓	-
	70x70	-	-	-	✓	-	-	✓	-	-	✓	-	-
	Ø60	-	-	-	✓	-	-	✓	-	✓	✓	✓	-
Topalit Classic Venetto Atacama Cherry	60x60	-	-	-	✓	-	-	✓	-	✓	✓	✓	-
	70x70	-	-	-	✓	-	-	✓	-	-	✓	-	-
Werzalit Cerclés Werzalit Rimmed Marrakesh Mermer Black Siyah	Ø60	-	-	-	✓	-	-	✓	-	✓	✓	✓	-
Stratifié Perfect Sense Collection Perfect Sense Laminate 20mm Noir - Black	60x60	-	-	-	✓	-	-	✓	-	✓	✓	✓	-
	70x70	✓	-	-	✓	-	-	✓	-	-	✓	-	-
	120x70	-	-	-	-	-	✓	-	✓	-	-	-	-
Stratifié Original Collection Original Collection Laminate 24mm Marbre Blanc - White Marble Béton Concrete Marmara Minnesota Oak Greige	60x60	-	-	-	✓	-	-	✓	-	✓	✓	✓	-
	70x70	✓	-	-	✓	-	-	✓	-	-	✓	-	-
	80x80	-	-	-	-	-	-	-	-	-	✓	-	✓
	60x70	-	✓	-	✓	✓	-	✓	-	-	✓	-	-
	110x70	-	-	✓	-	✓	✓	-	✓	-	-	-	-
	120x70	-	-	-	-	-	✓	-	✓	-	-	-	-
	120x80	-	-	-	-	-	✓	-	✓	-	-	-	-
Stratifié Chêne Halifax Oak Halifax Laminate 24mm & 46mm Chêne Halifax Naturel Chêne Halifax Tabac	Ø70	-	-	-	✓	-	-	✓	-	✓	✓	✓	✓
	Ø120	-	-	-	-	-	-	-	-	-	-	-	✓
	60x60	-	-	-	✓	-	-	✓	-	✓	✓	✓	-
Mélaminé Melamine 18mm Minnesota Oak Chocolat Chêne Halifax Naturel	70x70	✓	-	-	✓	-	-	✓	-	-	✓	-	-
	120x70	-	-	-	-	-	✓	-	✓	-	-	-	-
	60x60	-	-	-	✓	-	-	✓	-	✓	✓	✓	-
Chêne Odense Oak Odense 30mm	70x70	-	-	-	✓	-	-	✓	-	-	✓	-	-
	120x70	-	-	-	-	-	✓	-	✓	-	-	-	-

Correspondance Pieds/Plateaux

Matching table tops and bases

Piètements Intérieurs <i>Indoor Table Bases</i>		Rome 05	Rome 06	Rome 05 Bar	Rome 12	Rome 13	Rome 12 Bar	Sydney 4	Sydney 2	Sydney 4 Bar
Compact Easy	65x65	-	✓	-	✓	-	✓	✓	-	✓
Werzalit Classic Avalon Pine Irony Malaga Grey Marble	60x60	✓	-	✓	✓	-	✓	✓	-	✓
	70x70	-	✓	-	✓	-	✓	✓	-	✓
	Ø60	✓	-	✓	✓	-	✓	✓	-	✓
Topalit Classic Venetto Atacama Cherry	60x60	✓	-	✓	✓	-	✓	✓	-	✓
	70x70x	-	✓	-	✓	-	✓	✓	-	✓
Werzalit Cerclés <i>Werzalit Rimmed</i> Marrakesh Mermer Black Siyah	Ø60	✓	-	✓	✓	-	✓	✓	-	✓
Stratifié Perfect Sense Collection <i>Perfect Sense Laminate</i> 20mm Noir - Black	60x60	✓	-	✓	✓	-	✓	✓	-	✓
	70x70	-	✓	-	✓	-	✓	✓	-	✓
	120x70	-	-	-	-	✓	-	-	✓	-
Stratifié Original Collection <i>Original Collection Laminate</i> 24mm Marbre Blanc - White Marble Béton Concrete Marmara Minnesota Oak Greige	60x60	✓	-	✓	✓	-	✓	✓	-	✓
	70x70	-	✓	-	✓	-	✓	✓	-	✓
	80x80	-	✓	-	✓	-	-	-	-	-
	60x70	-	✓	-	✓	✓	✓	✓	-	✓
	110x70	-	-	-	-	✓	-	-	✓	-
	120x70	-	-	-	-	✓	-	-	✓	-
	120x80	-	-	-	-	✓	-	-	✓	-
Stratifié Chêne Halifax <i>Oak Halifax Laminate</i> 24mm & 46mm Chêne Halifax Naturel Chêne Halifax Tabac	Ø70	✓	✓	✓	✓	✓	✓	✓	-	✓
	Ø120	-	✓	-	-	-	-	-	-	-
	60x60	✓	-	✓	✓	-	✓	✓	-	✓
Mélaminé <i>Melamine</i> 18mm Minnesota Oak Chocolat Chêne Halifax Naturel	70x70	-	✓	-	✓	-	✓	✓	-	✓
	120x70	-	-	-	-	✓	-	-	✓	-
	60x60	✓	-	✓	✓	-	✓	✓	-	✓
Chêne Odense <i>Oak Odense</i> 30mm	70x70	-	✓	-	✓	-	✓	✓	-	✓
	120x70	-	-	-	-	✓	-	-	✓	-

Pièces détachées

Spare parts

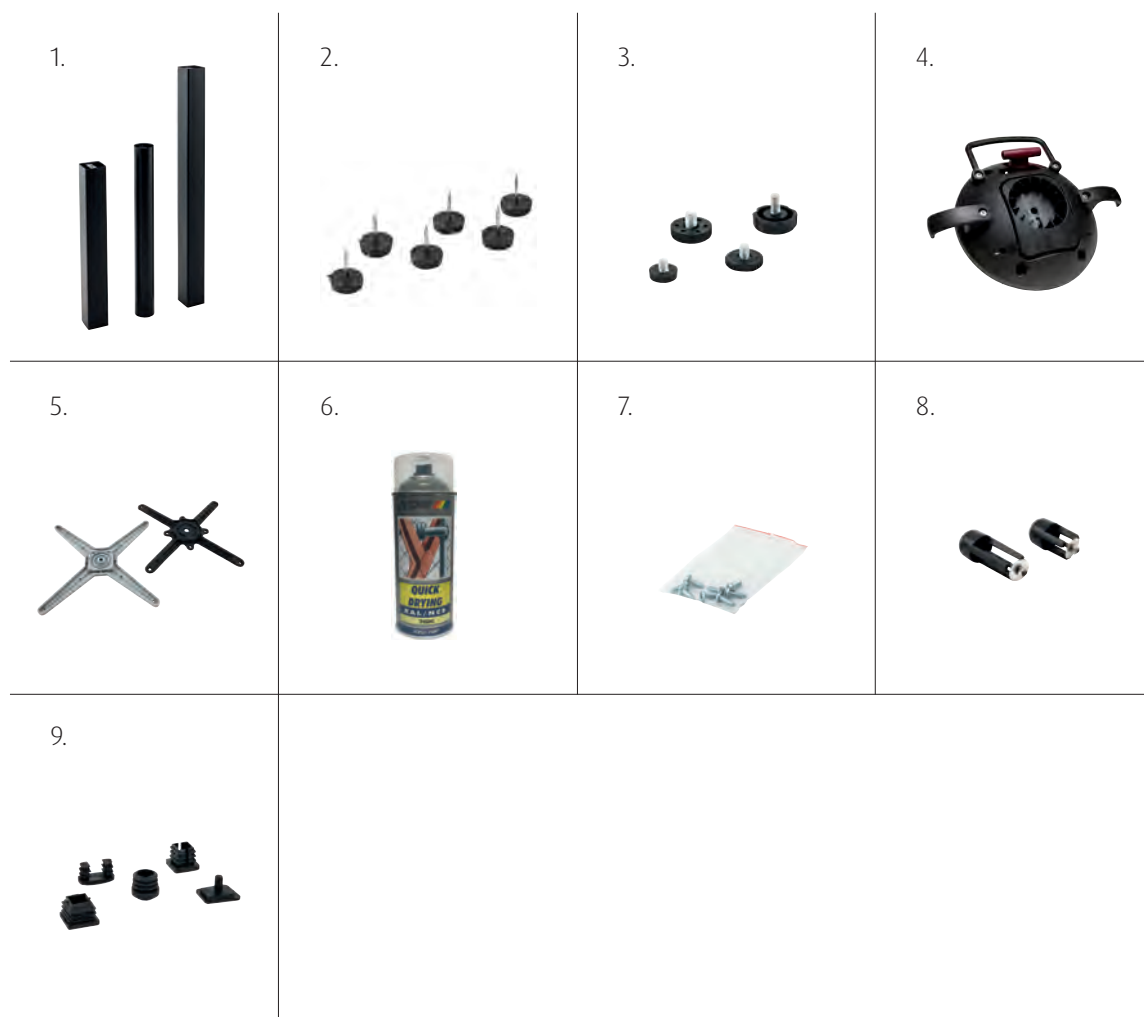

1. Tubes métalliques pour piètements intérieurs. *Metal tubes for indoor table bases.* 2. Patins en nylon à clouer pour mobilier en bois. *Nylon gliders for wooden furniture.* 3. Vérins de réglage pour piètements. *Table bases plugs.* 4. Verona Système basculant. *Verona fliptop system.* 5. Croix de fixation pour piètements. *Cross for table bases.* 6. Bombe aérosol de couleur pour la gamme Bastille & Pigalle - 400ml. *Colour spray can for the Bastille & Pigalle range - 400ml.* 7. Vis de montage pour plateaux de table. *Screws for tables tops.* 8. Empire éléments de fixation. *Assembly parts for the Empire table.* 9. Bouchons PVC pour mobilier intérieur et extérieur. *PVC plugs for outdoor and indoor furniture.*





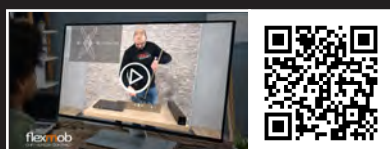



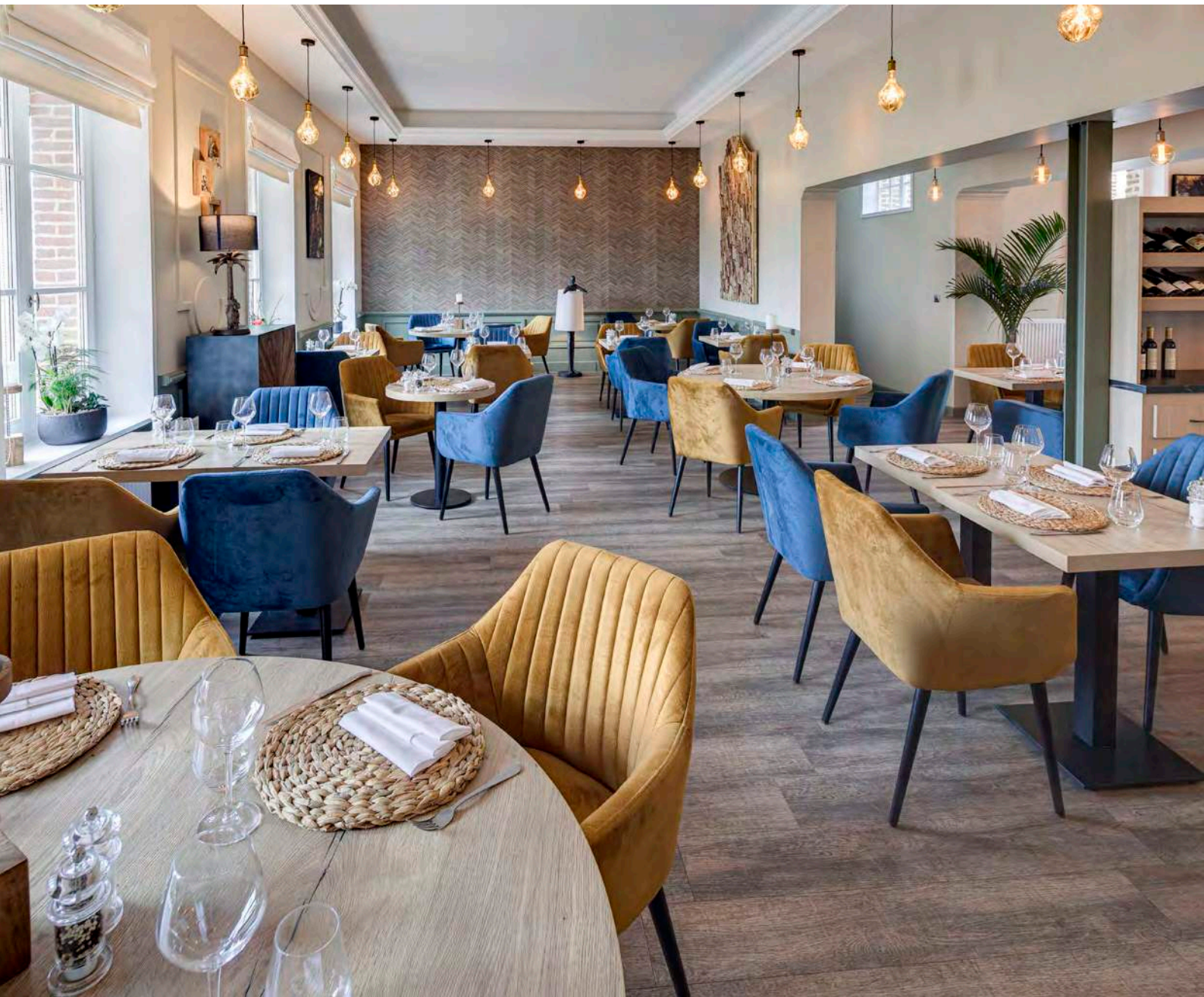















Vidéos de montage

Assembly videos



Retrouvez nos vidéos de montage via ce QR code.
Find our assembly videos via this QR code.



 <p>New</p> <p>Dax p08</p>	 <p>Orléans p10</p>	 <p>Rochelle p12</p>	 <p>New</p> <p>Laval p14</p>	 <p>Brest p16</p>
 <p>New</p> <p>Murcia p18</p>	 <p>New</p> <p>Cadix p20</p>	 <p>New</p> <p>Savana p22</p>	 <p>Amsterdam p24</p>	 <p>Breda p26</p>
 <p>Concorde p28</p>	 <p>Saint-Tropez p30</p>	 <p>New</p> <p>Villette p32</p>	 <p>Madeleine p34</p>	 <p>Passy p36</p>
 <p>New</p> <p>Reims p38</p>	 <p>New</p> <p>Blois p40</p>	 <p>New</p> <p>Dole p42</p>	 <p>Seine p44</p>	 <p>Louvre p46</p>
 <p>Dauphine p48</p>	 <p>Paris p50</p>	 <p>Montmartre p52</p>	 <p>Drouot p54</p>	 <p>Trocadero p56</p>

New



Bastille p58



Bastille Bst p60



Pigalle p62



Pack Bastille & Pigalle p64



Dubai p66



New

Jeddah p68



New

Oman p70



Penelope p72



Ulysse p74



Tom Bar 75 p76



Monna p78



Sky Pro p80



Maya p82



Maya Bar 75 p84



Fado p86



Atlantic p88



Marcel p90



Marcel XL p92



Marcel Bar 75 p94



Daytona p96



Panama p98



Jamaica p100























Jamaica F p102



Jamaica Bst p104



























Kys p106

























 <p>Kys Bar p108</p>	 <p>Pack Sky Pro & Kys p110</p>	 <p>Pack Tom Bar 75 & Kys Bar p111</p>		
 <p>Pack Maya & Kys p112</p>	 <p>Pack Maya Bar 75 & Kys Bar p113</p>	 <p>Eolo Pureti p114</p>		
 <p>Canto p116</p>	 <p>Verona 3 p118</p>	 <p>Verona Double p118</p>	 <p>Verona 4 p119</p>	 <p>Verona 4 Bar p119</p>
 <p>Monza p120</p>	 <p>Monza Bar p120</p>	 <p>Berlin 2 p122</p>	 <p>Berlin 4 p122</p>	 <p>Berlin 4 Bar p123</p>
 <p>Empire 3 p124</p>	 <p>Empire 4 p124</p>	 <p>Empire 4 Bar p124</p>	 <p>Empire 2 p125</p>	 <p>Empire Grande p125</p>

























 Bistrot 3 H43 p126	 Bistrot 3 p126	 Bistrot 4 p127	 Bistrot 4 Bar p127	 Compact Easy p128
 Werzalit Classic p130	 Topalit Classic p132	 Werzalit Cerclés p134		













New

New

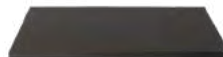
 <p>New</p> <p>Simone p138</p>	 <p>New</p> <p>René p140</p>	 <p>New</p> <p>Auguste p142</p>	 <p>New</p> <p>Mélina p144</p>	 <p>New</p> <p>Sandra p146</p>
 <p>New</p> <p>Noëlia p148</p>	 <p>New</p> <p>Zoé p150</p>	 <p>New</p> <p>Ralph p152</p>	 <p>New</p> <p>Paulette p154</p>	 <p>New</p> <p>Colette p156</p>
 <p>Adèle p158</p>	 <p>Victoire Bst p160</p>	 <p>New</p> <p>Mikka p162</p>	 <p>New</p> <p>Olaf p164</p>	 <p>New</p> <p>Jacob p166</p>
 <p>New</p> <p>Kyle p168</p>	 <p>New</p> <p>Wendy p170</p>	 <p>Maurice p172</p>	 <p>New</p> <p>Maurice Bst p174</p>	 <p>New</p> <p>College p176</p>
 <p>New</p> <p>Montreal p178</p>	 <p>Stanley p180</p>	 <p>Stanley Bst p182</p>	 <p>Brixton p184</p>	 <p>Soho p186</p>

				
Alex p188	Barossa p190	Condor p192	Pickup p194	Cuba p196
				
Cuba Double p198	Kate p200	Budapest p202	Budapest Bst p204	Dimitri p206
				
Dimitri Bst p208	Brooklyn p210	Brooklyn Bst p212	Pub p214	Pub Bst p216
				
Sofia p218	Sofia Bst p220	Maurice p222	Maurice Bst p224	Emile p226
				
Alfonse p228	Oscar Bst p230	Lautrec S p232	Arnold p234	Willy p236

 <p>New</p> <p>Floriane II p238</p>	 <p>New</p> <p>Floriane Bst II p240</p>	 <p>Clinton p242</p>	 <p>Clinton Bst p244</p>	 <p>New</p> <p>Maryne p246</p>
 <p>New</p> <p>Jolyne p248</p>	 <p>Ellen p250</p>	 <p>Factory p252</p>	 <p>Retro p253</p>	 <p>Retro p253</p>
 <p>Bistrot 3 H43 p244</p>	 <p>Bistrot 3 p244</p>	 <p>Bistrot 4 p245</p>	 <p>Bistrot 3 Bar p245</p>	 <p>Prato 16 p256</p>
 <p>Prato 19 p256</p>	 <p>Prato 30 p256</p>	 <p>Prato 16 Bar p257</p>	 <p>Prato 30 Bar p257</p>	 <p>Prato 15 p258</p>
 <p>Prato 20 p258</p>	 <p>Prato 15 Bar p259</p>	 <p>Prato 70 p259</p>	 <p>Rome 05 p260</p>	 <p>Rome 06 p260</p>

 <p>Rome 05 Bar p260</p>	 <p>Rome 12 p261</p>	 <p>Rome 13 p261</p>	 <p>Rome 12 Bar p261</p>	 <p>Sydney 4 p262</p>
 <p>Sydney Double p262</p>	 <p>Sydney 4 Bar p263</p>	<p>New</p>  <p>Stratifie Perfect Sense Collection p264</p>	<p>New</p>  <p>Stratifie Original Collection p266</p>	 <p>Stratifie Chêne Halifax p268</p>
 <p>Mélaminé p270</p>	 <p>Odense p270</p>	 <p>William p274</p>	 <p>Jacky p276</p>	

Index

Réception - Catering



Daisy p280



Tiffany p282



Napoléon p284

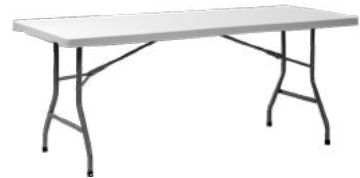

XL 180 p286



Cocktail 80 p287



Osaka p288



Pack Cocktail 80 & Osaka p289

A series of horizontal dotted lines for writing notes.

